

$$T = \frac{A - 12}{2} \quad P = \frac{A + 12}{2}$$

$$T = \frac{A - 50}{2} \quad P = \frac{A + 18}{2}$$

2 Internal side
Lato interno
Lado interior
Côte intérieur
Lato interno

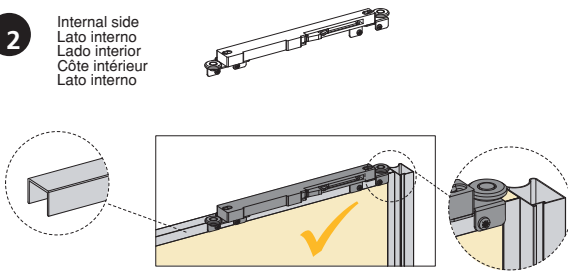

3

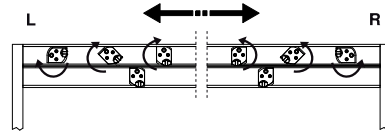
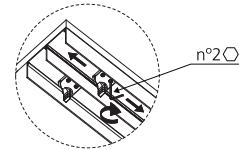
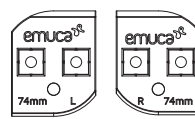

4

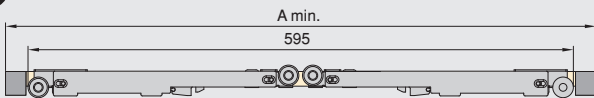

HANDLES MANIGLIE TIRADORES POIGNÉES PUXADORES	STYLE 16	WAVE 16	SHARP 16	WAVE 18	SHARP 18	WAVE 19	SHARP 19
A min.	642 mm	634 mm	634 mm	634 mm	634 mm	634 mm	634 mm

5

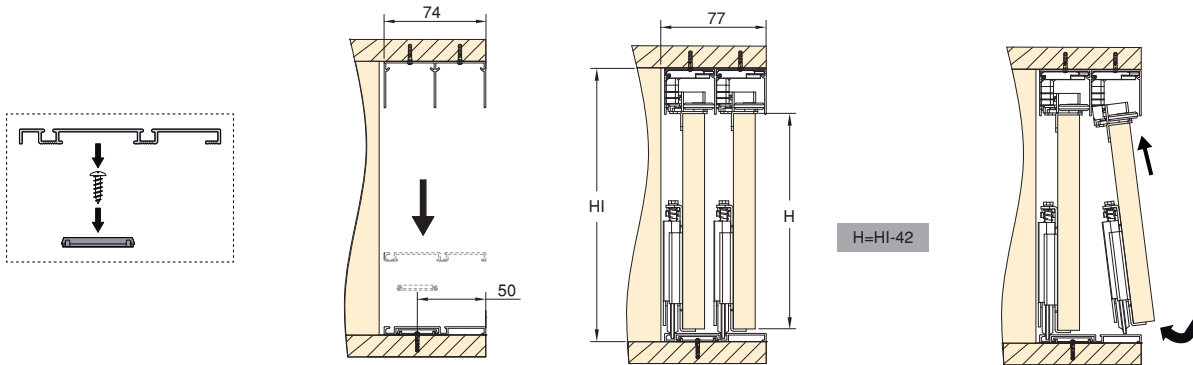

6

A

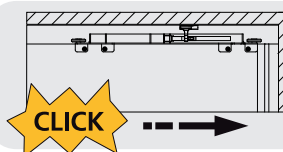
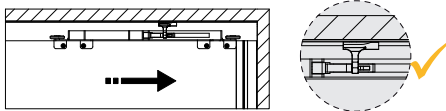

Adjustment closing (first time)
Regolazione per chiusura (prima volta)
Ajuste de cierre (primera vez)
L'ajustement la fermeture (la première fois)
Ajuste o feche (primeira vez)

B

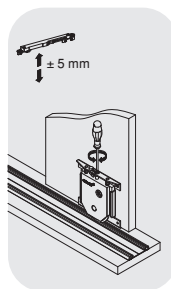
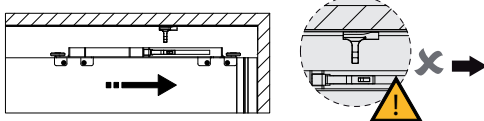

C

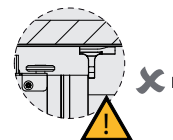
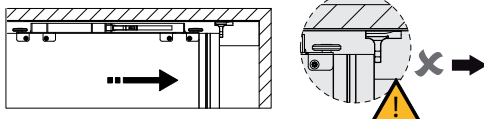

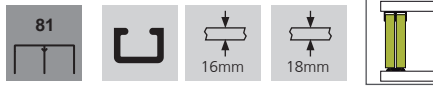

Model		
Wave		$T = \frac{A - 64}{2}$ $P = \frac{A + 20}{2}$
Sharp		$T = \frac{A - 45}{2}$ $P = \frac{A + 15}{2}$
Quad		$T = \frac{A - 105}{2}$ $P = \frac{A + 35}{2}$
Deep		$T = \frac{A - 64}{2}$ $P = \frac{A + 20}{2}$

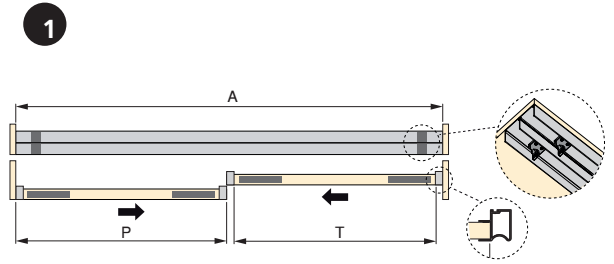
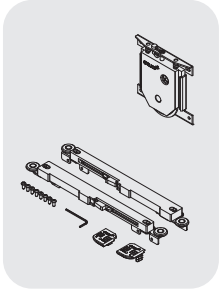

2 Internal side
Lato interno
Lado interior
Côte intérieur
Lato interno

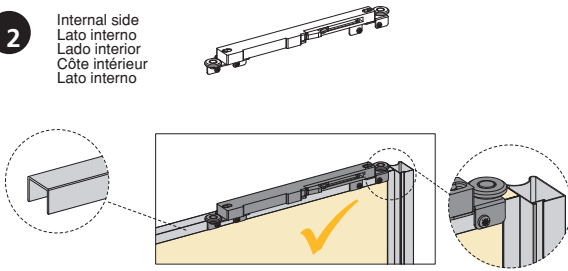

3

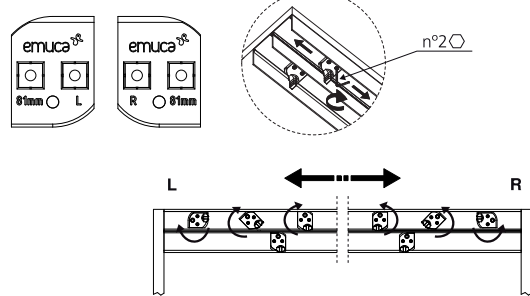

4

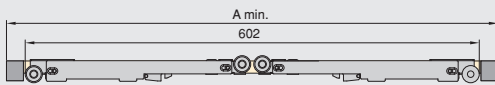

HANDLES MANIGLIE TIRADORES POIGNÉES PULXADORES							
A min.	656 mm	684 mm	640 mm	684 mm	656 mm	640mm	656mm

5

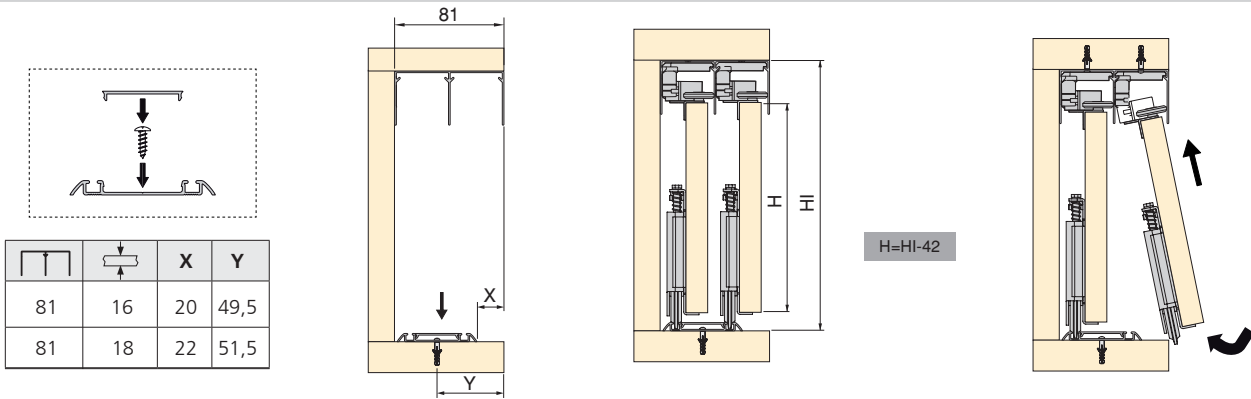

6

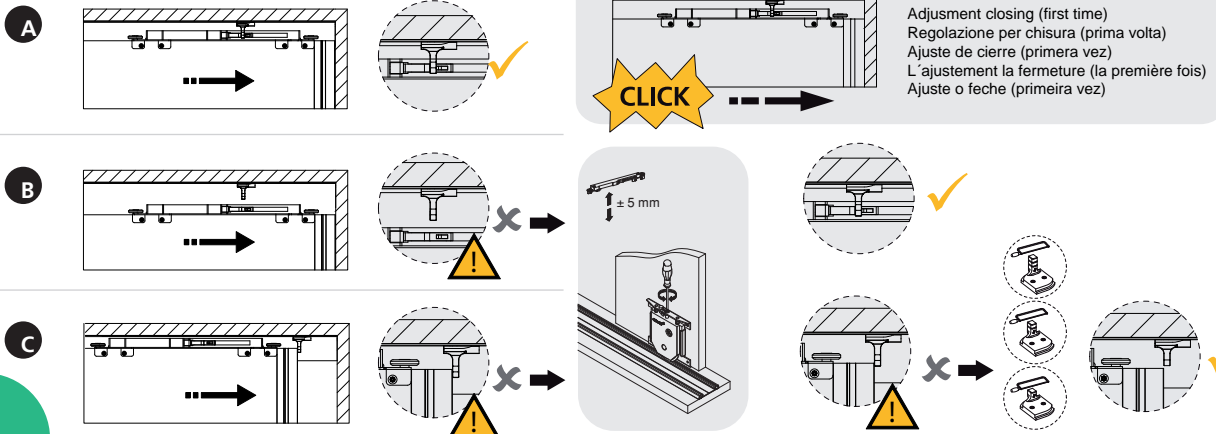

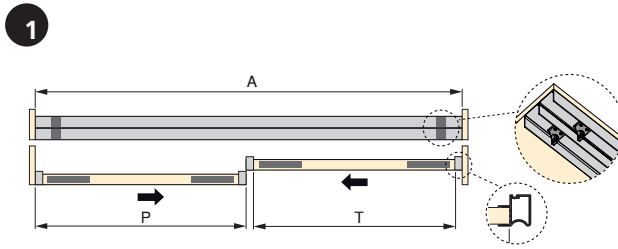
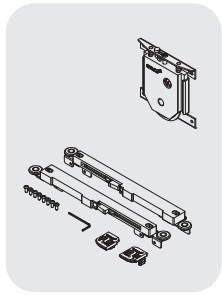

VALL 19	$T = \frac{A + 16}{2}$	$P = \frac{A + 28}{2}$
HILL 19	$T = \frac{A + 30}{2}$	$P = \frac{A + 34}{2}$
LINE 19	$T = \frac{A + 16}{2}$	$P = \frac{A + 20}{2}$

2 Internal side
Lato interno
Lado interior
Côté intérieur
Lato interno

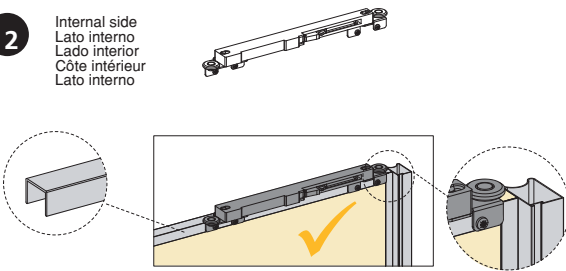

3

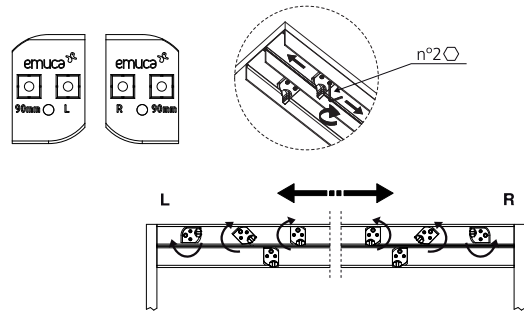

4

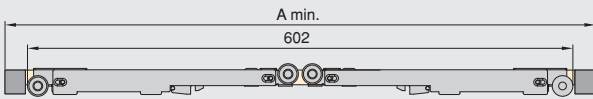

HANDLES MANGLIE TIRADORES POIGNÉES PUXADORES	VALL 19	HILL 19	LINE 19
A min.	636 mm	636 mm	628 mm

5

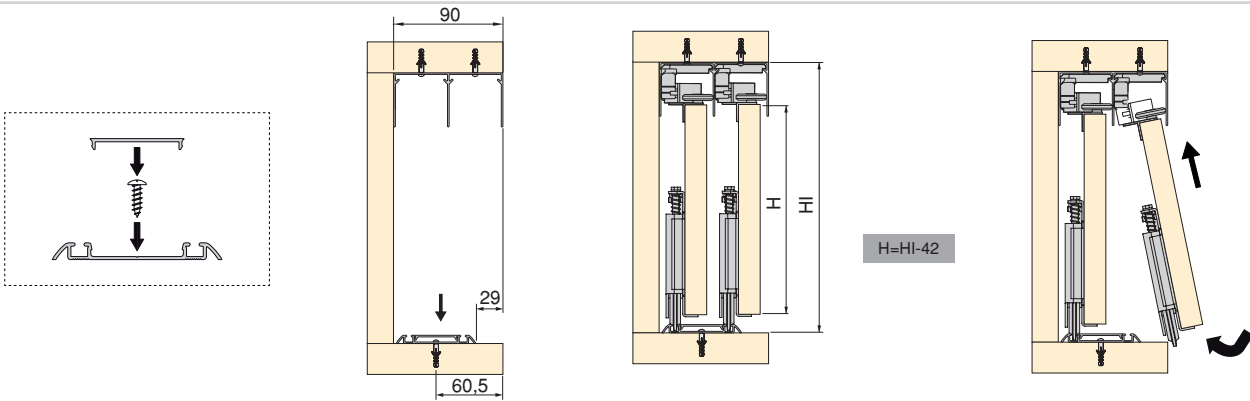

6

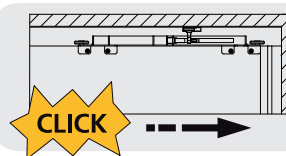
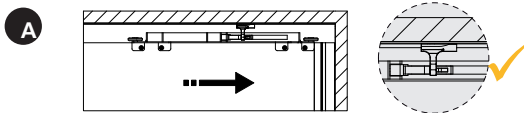

Adjustment closing (first time)
Regolazione per chiusura (prima volta)
Ajuste de cierre (primera vez)
L'ajustement la fermeture (la première fois)
Ajuste o feche (primeira vez)

