



RDG100, RDG110, RDG110U



RDG100T, RDG160T, RDG160TU



RDG100T/H

Room thermostats with LCD for wall mounting

RDG100

RDG100T

RDG110, RDG110U

RDG160T, RDG160TU

RDG100T/H

Basic Documentation

Contents

1	About this document	4
1.1	Revision history	4
1.2	Reference documents.....	4
1.3	Before you start	5
1.3.1	Copyright.....	5
1.3.2	Quality assurance	5
1.3.3	Document use/request to the reader	5
2	Summary	6
2.1	Brief description	6
2.2	Types and features	7
2.3	Equipment combinations	8
2.4	Accessories	9
2.5	Ordering	9
3	Use	10
4	Functions	11
4.1	Temperature control.....	11
4.2	Operating modes	12
4.3	Room temperature setpoints	13
4.4	Setpoints and sequences	14
4.4.1	2-pipe and 2-stage applications	14
4.4.2	4-pipe applications	15
4.5	Applications overview	16
4.5.1	Applications for fan coil systems.....	16
4.5.2	Applications for Universal systems	17
4.5.3	Applications for heat pump systems (RDG110., RDG160T..)	18
4.6	Additional features	19
4.6.1	Qx- relay switching functions (RDG160T.. only)	24
4.7	Control sequences.....	25
4.7.1	Sequences overview (setting via parameter P01)	25
4.7.2	Control outputs configuration (setting via DIP switches 4/5 and parameters)	26
4.7.3	2-pipe fan coil unit.....	27
4.7.4	2-pipe fan coil unit with electric heater	28
4.7.5	2-pipe fan coil unit with radiator or floor heating	30
4.7.6	4-pipe fan coil unit.....	31
4.7.7	4-pipe fan coil unit with electric heater (RDG100..)	33
4.7.8	2-stage heating or cooling.....	35
4.7.9	Chilled/heated ceiling and radiator applications	37
4.7.10	Compressor applications (general)	37
4.7.11	1-stage heating or cooling with reversing valve (RDG110..).....	38
4.8	Control outputs	39
4.9	Fan control.....	42
4.10	Multifunctional input, digital input	47
4.11	Auto timer (RDG100T, RDG100T/H, RDG160T.. only).....	48
4.12	Handling faults	51
4.13	Infrared remote control.....	51
4.14	DIP switches.....	51
4.15	Control parameters	52
4.15.1	Parameters of the "Service level" – Degree Celsius.....	53
4.15.2	Parameters of the "Expert level with diagnostics and test" – Degree Celsius	54

4.15.3	Parameters of the "Service level" – Degree Fahrenheit	56
4.15.4	Parameters of the "Expert level with diagnostics and test" – Degree Fahrenheit	57
4.15.5	Diagnostics and tests	59
5	Handling	60
5.1	Mounting and installation	60
5.2	Operation	62
5.3	Disposal	64
6	Engineering	65
6.1	Connection terminals	65
6.2	Connection diagrams	66
7	Mechanical design	71
7.1	General	71
7.2	Dimensions	72
8	Technical data	73

1 About this document

1.1 Revision history

Edition	Date	Changes	Section	Pages
4.1	June 2015	<ul style="list-style-type: none">• Add inch dimensions• Add degree Fahrenheit information for RDG110U and RDG160TU	All	
4.0	Feb 2015	<ul style="list-style-type: none">• Add new variants RDG110U and RDG160TU and other corrections	All	
3.0	April 2014	<ul style="list-style-type: none">• Protection via circuit breaker• Combination control outputs with relay function• New product RDG160T• Removed RDG140, RDG160• Doc valid for RDG100.. SW > = V7.2• Removed remarks for RDG100 SW < V7.2 (info in Doc V2.0)• RoHS-II adaptations• Several corrections	5.1, 6.2, 8 All	
2.0	Dec 2011	Amendments concerning RDG100T/H Adaptive temperature adaption (electric heater) Function specifications for units with SW < V7.2	All 4.8, 4.15	
1.1	June 2009	Several small corrections	All	
1.0	May 2009	First edition		

1.2 Reference documents

Ref.	Document title	Type of document	Document no.
[1]	Wall-mounted room thermostats with LCD	Data Sheet	N3181
[2]	RDG1..., RDG110U	Operating Instructions	B3181.1
[3]	RDG100T, RDG160T, RDG160TU	Operating Instructions	B3181.5
[4]	RDG100, RDG100T	Mounting Instructions	M3181.1
[5]	RDG110	Mounting Instructions	M3181.2
[6]	RDG160T	Mounting Instructions	M3181.5
[7]	RDG100T/H	Mounting Instructions	M3181.4
[8]	RDG100T/H	Operating Instructions	B3181.4
[9]	RDG110U	Mounting Instructions	M3183.1
[10]	RDG160TU	Mounting Instructions	M3183.2

1.3 Before you start

1.3.1 Copyright

This document may be duplicated and distributed only with the express permission of Siemens, and may be passed only to authorized persons or companies with the required technical knowledge.

1.3.2 Quality assurance

This document was prepared with great care.

- The contents of this document are checked at regular intervals
- Any corrections necessary are included in subsequent versions
- Documents are automatically amended as a consequence of modifications and corrections to the products described

Please make sure that you are aware of the latest document revision date.

If you find lack of clarity while using this document, or if you have any criticisms or suggestions, please contact the Product Manager in your nearest branch office. The addresses of the Siemens Regional Companies are available at www.siemens.com/sbt.

1.3.3 Document use/request to the reader

Before using our products, it is important that you read the documents supplied with or ordered at the same time as the products (equipment, applications, tools, etc.) carefully and in full.

We assume that persons using our products and documents are authorized and trained appropriately and have the technical knowledge required to use our products as intended.

More information on the products and applications is available:

- On the intranet (Siemens employees only) at <https://workspace.sbt.siemens.com/content/00001123/default.aspx>
- From the Siemens branch office near you www.buildingtechnologies.siemens.com or from your system supplier
- From the support team at headquarters fieldsupport-zug.ch.sbt@siemens.com if there is no local point of contact

Siemens assumes no liability to the extent allowed under the law for any losses resulting from a failure to comply with the aforementioned points or for the improper compliance of the same.

2 Summary

2.1 Brief description

Applications

- 2-pipe fan coil units, 2-pipe with electric heater, 2-pipe with radiator/floor heating
- 4-pipe fan coil units, 4-pipe with electric heater
- 2-stage heating or cooling application
- Compressors in dx-type equipment
- Universal heating and/or cooling

Features

- 2 multifunctional inputs and 1 digital input for keycard contact, external sensor, etc.
- Operating modes: Comfort, Economy and Protection
- Automatic or manual heating/cooling changeover
- Adjustable commissioning and control parameters
- Minimum and maximum setpoint limitation
- Backlit LCD
- Selection of fan stage in the dead zone via P15

RDG100/RDG100T..:

- On/Off, PWM or 3-position control outputs (triacs)
- Output for 3-speed or 1-speed fan
- AC 230 V operating voltage

RDG110..:

- On/Off control outputs (relay, SPDT)
- Output for 3-speed or 1-speed fan
- AC 230 V operating voltage (RDG110)
- AC/DC 24 V operating voltage (RDG110U)

RDG160T..:

- DC 0...10 V or On/Off control outputs for actuators
- DC 0...10 V or relay outputs for fan (ECM or 1-/3- speed)
- AC/DC 24 V operating voltage

Additional features

RDG100T, RDG160T.., RDG100T/H:

- Infrared remote control receiver
- Auto Timer mode with 8 programmable timers
- Auto timer can be disabled via P02
- Auto timer can be disabled via DIP switches (RDG160T..)
- Landscape design (only RDG100T/H)

Functions

- Maintenance of room temperature via built-in temperature sensor or external room temperature/return air temperature sensor
- Automatic or manual changeover between heating and cooling mode
- Selection of applications via DIP switches
- Selection of operating mode via the operating mode button on the thermostat
- 1-speed, 3-speed or DC...10 V fan control (automatic or manual)
- Display of current room temperature or setpoint in °C and/or °F
- Minimum and maximum setpoint limitation
- Button lock (automatic or manual)
- 1 digital input, freely selectable for:
 - Operating mode switchover contact (keycard)
 - Automatic heating/cooling changeover contact
 - Electric heater enable
 - Dewpoint sensor

- Fault input
- 2 multifunctional inputs, freely selectable for:
 - Operating mode switchover contact (keycard)
 - Automatic heating/cooling changeover sensor
 - External room temperature or return air temperature
 - Dewpoint sensor
 - Electric heater enable
 - Fault input
 - Supply air temperature sensor (RDG160T..)
- Advanced fan control function, i.e. fan kick, fan start, selectable fan operation (enable, disable or depending on heating or cooling mode)
- Purge function together with 2-port valve in a 2-pipe changeover system
- Reminder to clean filters
- Floor heating temperature limit
- Minimum and maximum supply air temperature limitation (RDG160T..)
- Reloading factory settings for commissioning and control parameters
- 7-day time program: 8 programmable timers to switch over between Comfort and Economy mode (RDG100T, RDG160T.., RDG100T/H)
- Infrared remote control (RDG100T, RDG160T.., RDG100T/H)
- Selectable relay function (RDG160T..)
 - For switching OFF external equipment OFF during Protection mode
 - For switching ON external equipment (e.g. pump) during H/C demand
 - Output heating/cooling sequence
- Wizard function to select working temperature unit °C or °F (RDG160TU, RDG110U)

2.2 Types and features

Product no.	Features										UL
	Operating voltage	Number of control outputs				Time program	Backlit LCD	Infrared receiver ¹⁾	Fan		
		On/Off	PWM	3-pos	DC 0..10 V				ECM ²⁾	3-speed	
RDG100	AC 230 V	3 ³⁾	2 ³⁾	2 ³⁾			✓			✓	
RDG100T	AC 230 V	3 ³⁾	2 ³⁾	2 ³⁾		(✓) ⁵⁾	✓	✓		✓	
RDG100T/H	AC 230 V	3 ³⁾	2 ³⁾	2 ³⁾		(✓) ⁵⁾	✓	✓		✓	
RDG110	AC 230 V	2 ⁴⁾					✓			✓	
RDG110U	AC/DC 24 V	2 ⁴⁾					✓			✓	✓
RDG160T	AC/DC 24 V				2	(✓) ⁵⁾	✓	✓		✓	
		2 ⁶⁾			2 ⁶⁾	(✓) ⁵⁾	✓	✓	✓		
RDG160TU	AC/DC 24 V				2	(✓) ⁵⁾	✓	✓		✓	✓
		2 ⁶⁾			2 ⁶⁾	(✓) ⁵⁾	✓	✓	✓		

¹⁾ Infrared remote control must be ordered as a separate item

²⁾ ECM fan output DC 0...10 V























³⁾ On/Off, PWM or 3-position (triac outputs)



⁴⁾ Relay output (SPDT)

⁵⁾ Can be disabled via P02 (or via DIP switches on RDG160T..)

⁶⁾ Either On/Off (relay output) or DC control signal

2.3 Equipment combinations

	Description		Product no.	Data Sheet
	Infrared remote control		IRA211	3059
	Cable temperature sensor or changeover sensor, cable length 2.5 m (8 feet) NTC (3 kΩ at 25 °C (77 °F))		QAH11.1	1840
	Room temperature sensor NTC (3 kΩ at 25 °C (77 °F))		QAA32	1747
	Cable temperature sensor, cable length 4 m (13 feet) NTC (3 kΩ at 25 °C (77 °F))		QAP1030/UFH	1854
	Condensation motion		QXA2601/ QXA2602/ QXA2603/ QXA2604	3302
On/Off actuators	Electromotoric On/Off valve and actuator (only available in AP, UAE, SA and IN)		MVI../MXI..	4867
	Electromotoric On/Off actuator		SFA21..	4863
	Zone valve actuators (only available in AP, UAE, SA and IN)		SUA..	4830
On/Off and PWM actuators ^{*)}	Thermal actuator (for radiator valves) AC 230 V, NO		STA23..	4884
	Thermal actuator (for radiator valves) AC 24 V, NO		STA73.. ^{*)}	4884 ^{*)}
	Thermal actuator AC 230 V (for small valves 2.5 mm (0.1")), NC		STP23..	4884
	Thermal actuator AC 24 V (for small valves 2.5 mm (0.1")), NC		STP73.. ^{*)}	4884 ^{*)}
3-position actuators	Electrical actuator, 3-position (for radiator valves)		SSA31..	4893
	Electrical actuator, 3-position (for 2- and 3-port valves/V..P45)		SSC31..	4895
	Electrical actuator, 3-position (for small valves 2.5 mm (0.1"))		SSP31..	4864
	Electrical actuator, 3-position (for small valves 5.5 mm (0.2"))		SSB31..	4891
	Electrical actuator, 3-position (for CombiValves VPI45)		SSD31..	4861
	Electromotoric actuator, 3-position (for valves 5.5 mm (0.2"))		SQS35..	4573
DC 0...10 V actuators	Electrical actuator, DC 0...10 V (for radiator valves)		SSA61..	4893
	Electrical actuator, DC 0...10 V (for 2- and 3-port valves/V..P45)		SSC61..	4895
	Electrical actuator, DC 0...10 V (for small valves 2.5 mm (0.1"))		SSP61..	4864
	Electrical actuator, DC 0...10 V (for small valves 5.5 mm (0.2"))		SSB61..	4891
	Electrical actuator, DC 0...10 V (for Combi-Valves VPI45)		SSD61..	4861

Electromotoric actuator, DC 0...10 V (for valves 5.5 mm (0.2"))		SQS65..	4573
Electrothermal actuator, AC 24 V, NC, DC 0...10 V, 2 m (6.6 feet) (for radiator valves and small valves 2.5 mm (0.1"))		STA63	4884
Electrothermal actuator, AC 24 V, NO, DC 0...10 V, 2 m (6.6 feet) (for radiator valves and small valves 2.5 mm (0.1"))		STP63	4884

⁷⁾ With PWM control, it is not possible to ensure exact parallel running of 2 or more thermal actuators. If several fan coil systems are controlled by the same room thermostat, preference should be given to motorized actuators with On/Off or 3-position control.

Note For more information about parallel operation and the maximum number of actuators that can be used, refer to Data Sheets of the selected type of actuator and the following list:

Maximum number of actuators in parallel on the RDG100..:

- 6 SS..31.. actuators (3-pos)
- 4 ST..23.. if used with On/Off control signal
- 10 SFA.., SUA.., MVI.., MXI.. On/Off actuators
- Parallel operation of SQS35 is not available

Maximum number of actuators in parallel on the RDG110..:

- 10 On/Off actuators

Maximum number of actuators in parallel on the RDG160T..:

- 10 SS..61.. actuators (DC)
- 10 ST..23/63/73.. actuators (DC or On/Off)
- 10 SFA.., SUA.., MVI.., MXI.. On/Off actuators
- 10 SQS65 actuators (DC)

2.4 Accessories

Description	Product no.	Data Sheet
Changeover mounting kit (50 pcs/package)	ARG86.3	3009

2.5 Ordering

Product no.	Stock no.	Designation
RDG100	S55770-T158	Room thermostat
RDG100T	S55770-T159	Room thermostat, with timer
RDG100T/H	S55770-T235	Room thermostat, with timer, landscape housing
RDG110	S55770-T160	Room thermostat with relay outputs (AC 230 V)
RDG110U	S55770-T361	Room thermostat with relay outputs (AC/DC 24 V), UL certified
RDG160T	S55770-T343	Room thermostat with timer and DC (or On/Off) output for valve and fan (AC/DC 24 V)
RDG160TU	S55770-T362	Room thermostat with timer and DC (or On/Off) output for valve and fan (AC/DC 24 V), UL certified

Order the **IRA211** infrared remote control separately.

Order valve actuators separately.

Order RDG110U and RDG160TU from BT US.

3 Use

The RDG1.. room thermostats are designed for use with the following types of system:

Fan coil units via On/Off or modulating control outputs:

- 2-pipe system
- 2-pipe system with electric heater
- 2-pipe system and radiator/floor heating
- 4-pipe system
- 4-pipe system with electric heater
- 2-stage heating or cooling system

Chilled/heated ceilings (or radiators) via On/Off or modulating control outputs:

- Chilled/heated ceiling
- Chilled/heated ceiling with electric heater
- Chilled/heated ceiling and radiator/floor heating
- Chilled/heated ceiling, 2-stage cooling or heating

Heat pumps with dx-type equipment:

- 1-stage compressor for heating or cooling
- 1-stage compressor for heating or cooling with electric heater
- 1-stage compressor for heating or cooling and radiator/floor heating
- 1-stage compressor for heating and cooling
- 1-stage compressor for heating and cooling with reversing valve
- 2-stage compressor for heating or cooling

4 Functions

4.1 Temperature control

General note

Setting of the control parameters (P01, etc., mentioned throughout the document) is described in section 4.15.

The thermostat acquires the room temperature via built-in sensor, external room temperature sensor (QAA32), or external return air temperature sensor (QAH11.1), and maintains the setpoint by delivering actuator control commands to heating and/or cooling equipment. The following control outputs are available depending on the thermostat type:

1-speed/3-speed fan:

- On/Off control on **RDG100, RDG100T, RDG100T/H, RDG110..**
- Modulating PI/P control with 3-position control output on **RDG100, RDG100T, RDG100T/H**
- Modulating PI/P control with PWM output on **RDG100, RDG100T, RDG100T/H**
- Modulating PI/P control with DC 0...10 V control output on **RDG160T..**

ECM fan:

- On/Off control on **RDG160T..**
- Modulating PI/P control with DC 0...10 V control output on **RDG160T..**

The switching differential or proportional band is 2 K (4 °F) for heating mode and 1 K (2 °F) for cooling mode (adjustable via parameters P30 and P31).

The integral action time for modulating PI control is adjustable via parameter P35.

Temperature unit selection wizard (only for RDG110U/RDG160TU)

The temperature unit selection wizard enables to select the preferable temperature unit display on thermostats between °C and °F under the following two situations:

1. Select the application via the DIP switches at the rear of thermostat before fitting the front housing to the mounting plate.
2. Power up the thermostat after successfully connecting the line power.

Follow the steps:

1. Rotate rotary knob to select the preferable temperature unit.
2. Press the button  (OK) to confirm the selection, and the thermostat goes to normal operating page.





Notes

- Pressing button  (Esc) does not confirm the temperature selection.
- If the temperature unit is not selected, °C is used by default.

Display

The display shows the acquired room temperature or the Comfort setpoint, selectable via parameter P06. The factory setting displays the current room temperature. Use parameter P04 to display the room temperature or setpoint in °F rather than °C as needed.











If the thermostat is used in a system with manual heating/cooling changeover (P01 = 2), the heating  and cooling  symbols on the display show the fan coil or terminal unit's status. Thus, the symbols are displayed even when the thermostat operates in the neutral zone. For all other cases, the heating  and cooling  symbols are displayed when the heating or cooling output is activated.

Concurrent display of °C and °F

















Concurrent display of the current temperature or setpoint in °C and °F (parameter P07) is possible on the thermostats without 7-day time program.

4.2 Operating modes

Select the thermostat's operating mode via the operating mode button on the unit or operating mode input (e.g. keycard occupancy sensor), when X1, X2, or D1 is set to 3 (P38, P40, P42). A corresponding setpoint is used to maintain the room temperature at the desired level depending on the active operating mode. The following operating modes are available:

- Comfort mode**  In Comfort mode, the thermostat maintains the room temperature setpoint which can be adjusted via the **rotary knob**. The fan can be set to automatic or manual fan speed: low, medium or high.
- Economy mode**  Economy mode helps save energy. Select it by pressing the operating mode button if parameter P02 is set accordingly, or if the external operating mode switchover contact is active (e.g. window contact).
- Note If the external operating mode switchover contact is active, user operations are ineffective and OFF is displayed. Control will then be according to Economy setpoints (P11 and P12).
- Protection mode**  In Protection mode, the system is
- protected against frost (factory setting **8 °C (46 °F)**, can be disabled or changed via P65)
 - protected against overheating (factory setting **OFF**, can be enabled or changed via P66).
- Auto Timer mode (with RDG100T, RDG100T/H, RDG160T.. only)**  In Auto Timer mode , the thermostat automatically changes from Comfort to Economy mode according to the 8 preprogrammed timers. The display shows the Auto Timer mode symbol  along with the symbol for the current operating mode (Comfort  or Economy ). Automatic is the default fan speed in Auto Timer mode. Auto Timer function can be disabled with parameter P02 = 3, 4 or via DIP switch 5 on RDG160T..

Operating mode button The behavior of the operating mode button can be selected via parameter P02:

#	Without time program	With time program (RDG100T, RDG100T/H, RDG160T.. only)	Remark
1	 → 	 →  → 	Factory setting
2	 →  → 	 →  →  → 	
3		 → 	
4		 →  → 	

4.3 Room temperature setpoints

Comfort mode ☀ The factory setting for the Comfort basic setpoint is **21 °C (70 °F)** and can be changed via parameter P08.

The setpoint in Comfort mode can be adjusted via the **rotary knob**.

Temporary setpoint If the "Temporary setpoint function" is enabled via parameter P69, the setpoint adjusted via the rotary knob is set back to the Comfort basic setpoint when the operating mode changes.

Setpoint limitation For comfort or energy saving purposes, the setpoint setting range can be limited to minimum (P09) and maximum (P10).

- P09 < P10
(comfort concept)
- If the minimum limit **P09 is set lower** than the maximum limit P10, both heating and cooling are adjustable between these 2 limits.
 - The customer adjusts the desired setpoint and the thermostat controls the room temperature accordingly.
 - For **4-pipe applications**[†], the selected comfort setpoint is in the middle of the dead zone (P33). The unit stops to energize the heating/cooling outputs as soon as the room temperature reaches the dead zone.

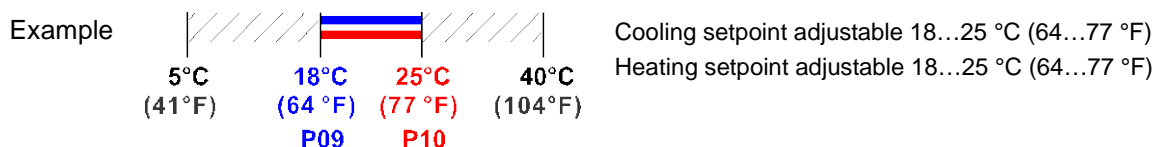

- P09 ≥ P10
(energy saving concept)
- If the minimum limit **P09 is set higher** than the limit P10, then
 - The setting range of cooling setpoint is from **P09...40 °C (P09...104 °F)** in place of 5...40 °C (41...104 °F)
 - The setting range of heating setpoint is from **5...P10 °C (41...P10 °F)** in place of 5...40 °C (41...104 °F)
- This allows the user to limit the maximum heating setpoint and the minimum cooling setpoint. This concept helps to save energy costs.

- For **4-pipe applications**:
 - The thermostat runs with the setpoint of the active sequence:
 - In heating mode, the heating setpoint is active and adjustable via rotary knob.
 - In cooling mode, the cooling setpoint is active and adjustable via rotary knob.
 - Switching from the heating setpoint to the cooling setpoint and vice-versa occurs when the room temperature reaches the adjusted limitation (P09 or P10) of the **inactive** sequence. E.g. the thermostat is in heating sequence and runs with the heating setpoint. When the room temperature reaches P09, the thermostat switches to cooling mode and runs with the cooling setpoint, as long as the room temperature does not drop below P10.

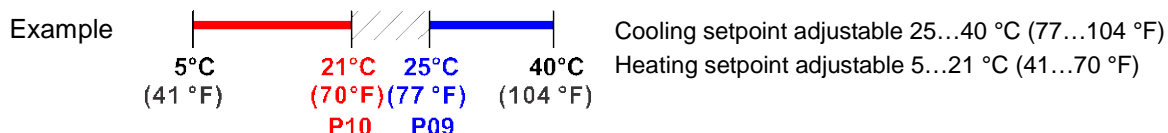

Economy mode ☾ Use control parameters P11 and P12 to adjust the Economy mode setpoints. The heating setpoint is factory-set to **15 °C (59 °F)**, and the cooling setpoint to **30 °C (86 °F)**.

Protection mode



Use control parameters P65 and P66 to adjust the Protection mode setpoints. The heating setpoint is factory-set to **8 °C (46 °F)** (frost protection) and to **OFF** for cooling.

Caution

If a setpoint is set to OFF (P65, P66), the thermostat does not maintain the setpoint in the corresponding mode (heating or cooling). This means no protective heating or cooling function and thus risk of frost in the heating mode or risk of overtemperature in cooling mode!

The Economy setpoints are accessible at the service level (P11, P12); the Protection setpoints at the expert level (P65, P66).

4.4 Setpoints and sequences

4.4.1 2-pipe and 2-stage applications

On changeover applications, the Comfort setpoints for heating and cooling sequence are the same (w).

On 2-pipe applications with electric heater, the Comfort setpoint is either at the first heating sequence (in heating mode) or at the cooling sequence (in cooling mode).

On 2-pipe applications with radiator, the Comfort setpoint is either at the radiator sequence (in heating mode) or at the cooling sequence (in cooling mode).

The setpoints for Economy and Protection mode are below the Comfort setpoints (heating) and above the Comfort setpoints (cooling). They can be set via parameters P11, P12 (Economy mode) and P65, P66 (Protection mode).

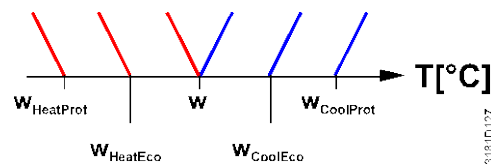

31810127

Application	Comfort mode		Economy/Protection mode	
	Heating mode	Cooling mode	Heating mode	Cooling mode
2-pipe				
2-pipe and electric heater				
2-pipe and radiator				
2-stage heating or cooling				

1) If P13 = ON

2) In case of manual changeover (P01=2), the first heating sequence is disabled to prevent heating (electric heater) and cooling (coil) at the same time

W = setpoint in Comfort mode

$W_{HeatEco/Prot}$ = setpoint heating in Economy or Protection mode

$W_{CoolEco/Prot}$ = setpoint cooling in Economy or Protection mode

YR = radiator sequence

YE = electric heater sequence

4.4.2 4-pipe applications

On 4-pipe applications, the Comfort setpoint (w) is in the middle of the dead zone, between the heating and cooling sequence.

The dead zone can be adjusted via parameter P33.

If manual changeover is selected, then either the cooling sequence or the heating sequence is released. In this case, the Comfort setpoint is at the selected heating or cooling sequence.

Application	Comfort mode			Economy/Protection mode
	Heating and Cooling	Heating mode ¹⁾	Cooling mode ¹⁾	Heating and/or cooling
4-pipe				
4-pipe and electric heater				

¹⁾ Manual changeover, P01=2

W = setpoint in Comfort mode

$W_{HeatEco/Prot}$ = heating setpoint for Economy or Protection mode

$W_{CoolEco/Prot}$ = cooling setpoint for Economy or Protection mode

YE = electric heater sequence

4.5 Applications overview

The thermostats support the following applications, which can be **configured via DIP switches** at the rear of the unit. Depending on the type of thermostat, On/Off or modulating control outputs are available.

4.5.1 Applications for fan coil systems

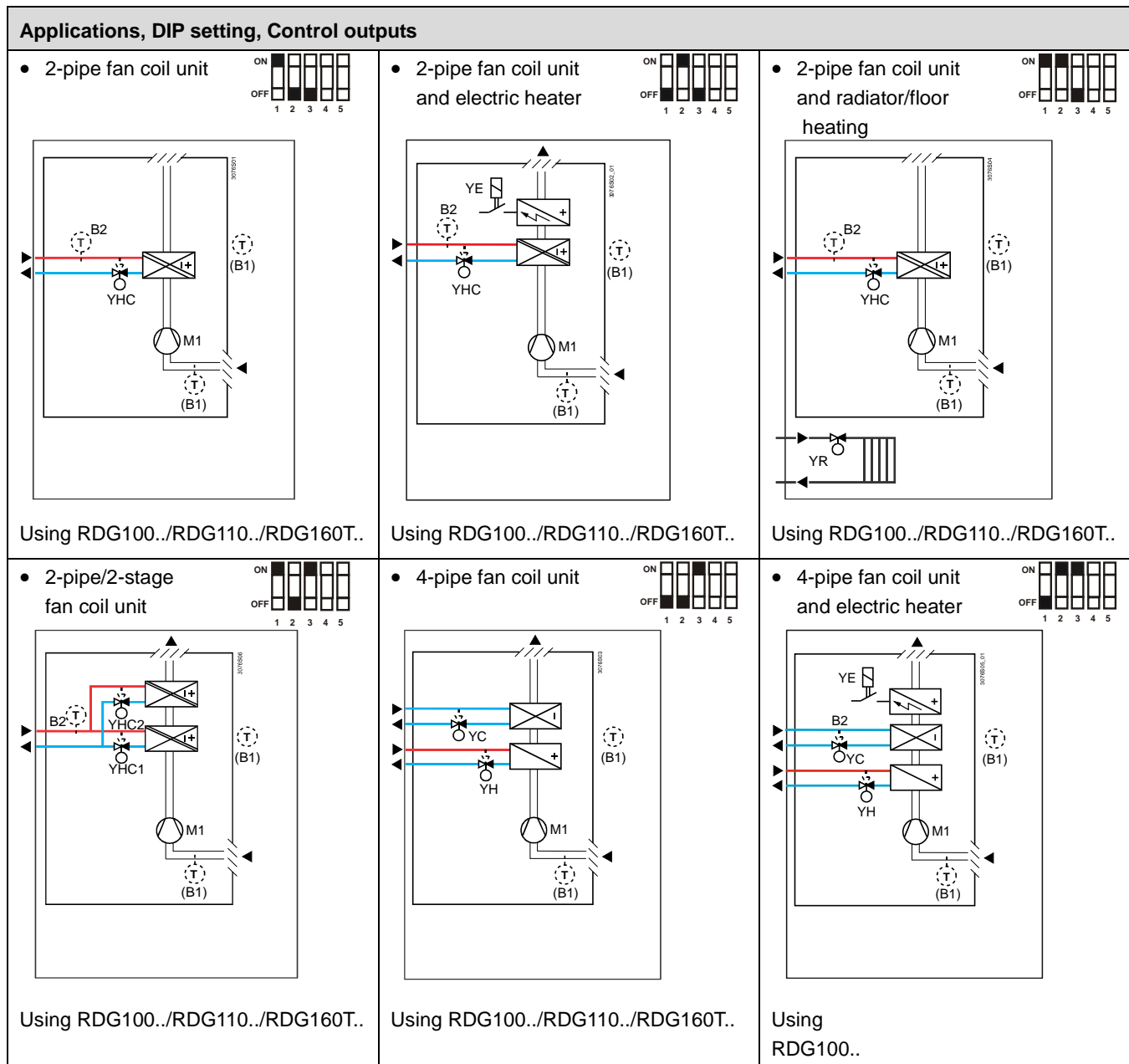

Product no.	Control outputs	Fan
RDG100	On/Off, PWM, 3-position	3-speed, 1-speed
RDG110/RDG110U	On/Off (SPDT)	3-speed, 1-speed
RDG160T/RDG160TU	DC 0..10 V	3-speed, 1-speed
	On/Off, DC 0...10 V	DC 0...10 V ECM

4.5.2 Applications for Universal systems

Applications, DIP setting, Control outputs	
<ul style="list-style-type: none"> Chilled/heated ceiling <p>Using RDG100../RDG110../RDG160T..</p>	<ul style="list-style-type: none"> Chilled/heated ceiling and electric heater <p>Using RDG100../RDG110../RDG160T..</p>
<ul style="list-style-type: none"> 2-stage chilled/heated ceiling <p>Using RDG100../RDG110../RDG160T..</p>	<ul style="list-style-type: none"> Chilled ceiling and radiator <p>Using RDG100../RDG110../RDG160T..</p>
<ul style="list-style-type: none"> Chilled/heated ceiling and radiator /floor heating <p>Using RDG100../RDG110../RDG160T..</p>	

Product no.	Control outputs
RDG100	On/Off, PWM, 3-position
RDG110/RDG110U	On/Off (SPDT)
RDG160T/RDG160TU	On/Off, DC 0...10 V

For more detailed information, refer to section 4.7.9.

4.5.3 Applications for heat pump systems (RDG110.., RDG160T..)

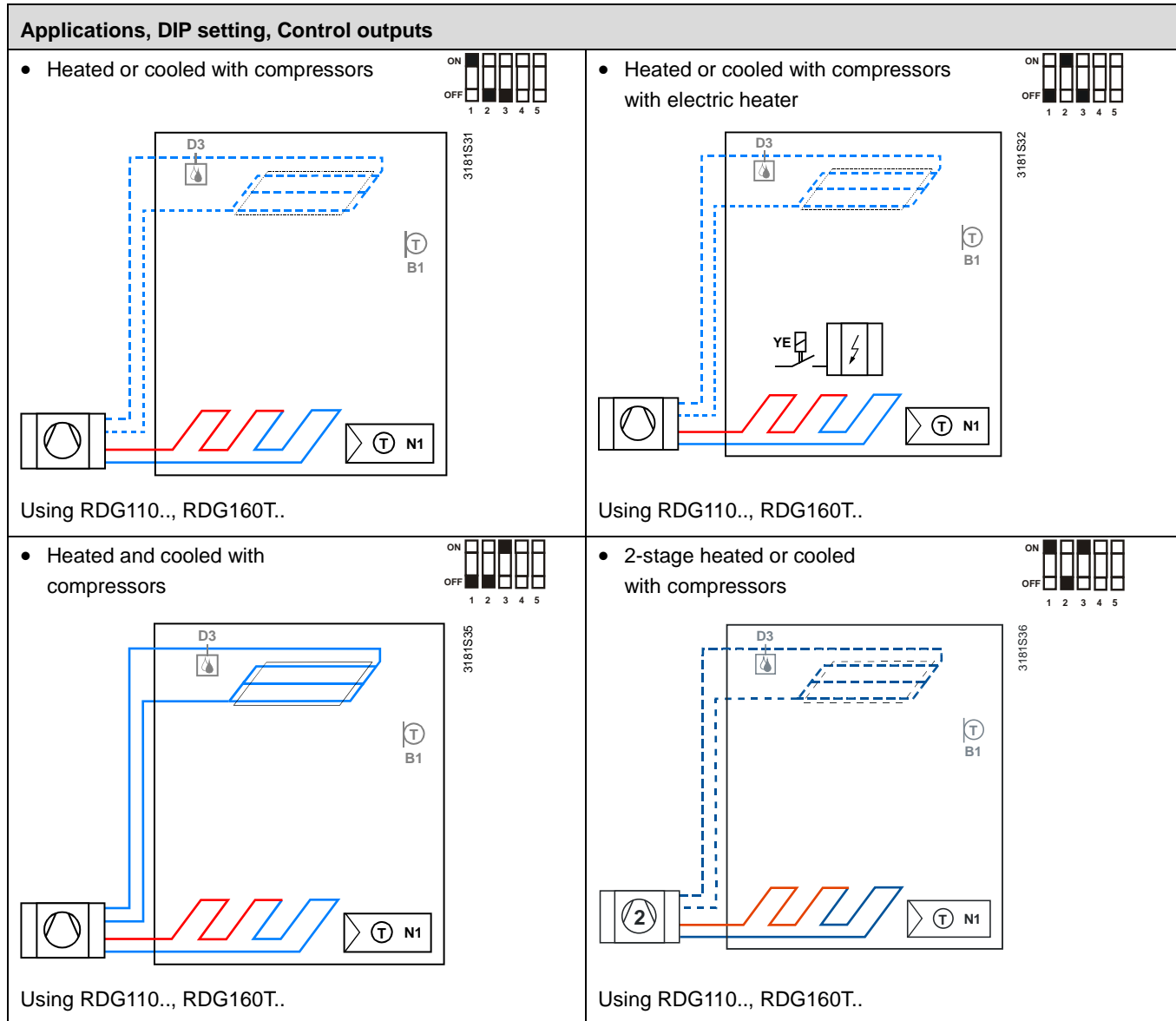

Product no.	Control outputs	Fan
RDG110/RDG110U	On/Off (SPDT)	Disabled, 3-speed, 1-speed
RDG160T/RDG160TU	On/Off, DC 0...10 V	Disabled, 3-speed, 1-speed, DC 0...10 V

Legend	YHC..	Heating/cooling valve actuator	M1	1-speed or 3-speed fan
	YH	Heating valve actuator	B1	Return air temperature sensor or external room temperature sensor (optional)
	YC	Cooling valve actuator	B2	Changeover sensor (optional)
	YE	Electric heater		

Notes RDG100..

- Use P46/P47 to change output from On/Off (factory setting) to PWM.
- Use DIP switches 4 and 5 to change output from On/Off to 3-position.

RDG110..

- Select DIP switches "OFF OFF ON" for application with reverse valve, see section 4.7.11.

RDG160T..

- Use P46/P47 to change valve actuator output from DC (factory setting) to On/Off.
- Use DIP switch 4 to change fan output from DC (factory setting) to 3-speed.

4.6 Additional features

Automatic heating/cooling changeover

The water temperature acquired by the changeover sensor (QAH11.1 + ARG86.3) is used to change over from heating to cooling mode, or vice versa.

- When the **water temperature** is above 28 °C (82 °F) (adjustable via parameter P37), the thermostat changes over to **heating mode**.
It stays in heating mode until the temperature falls below 16°C (61 °F) (adjustable via parameter P36)
- When the **water temperature** is below 16 °C (61 °F) (P36), the thermostat changes over to **cooling mode**.
It stays in cooling mode until the temperature rises above 28°C (82 °F) (P37).
- If the water temperature is between the 2 changeover points immediately after power-up (inside the hysteresis), the thermostat starts in previous mode.

The water temperature is acquired at 30-second intervals and the operating state is updated accordingly.

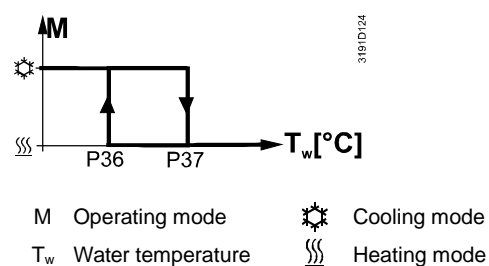

Remote heating/cooling changeover

The QAH11.1 cable temperature sensor for automatic heating/cooling changeover can be replaced by an external switch for manual, remote changeover:

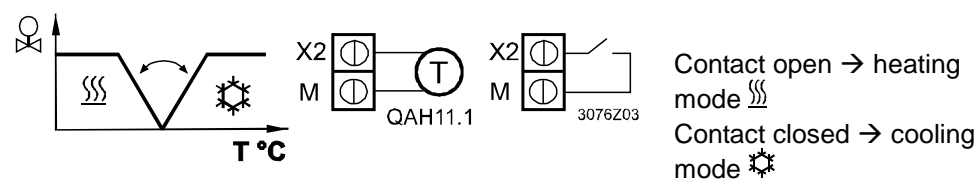

The sensor or switch can be connected to input terminal X2 (factory setting) or X1 or D1 (switch only), depending on the commissioning of the inputs (P38, P40, P42). See also section 4.10 for details.

Note The commissioning of the parameter *Operating action* (P39, P41, P42) has in this case no effect.

The assignment is fixed: Contact open → heating mode (wavy lines)
Contact closed → cooling mode (sun icon)

Manual heating/cooling changeover

- Manual heating/cooling changeover means selection via changeover button on the thermostat by repeatedly pushing the button until the required mode is shown on the display (automatic changeover is done via an external sensor/switch connected to X1, X2, or D1)
- If manual heating/cooling changeover is commissioned (P01 = 2), then heating/cooling mode cannot be changed via changeover sensor/switch; it will remain in the last mode as selected locally via button.

External/return air temperature sensor

The thermostat acquires the room temperature via built-in sensor, external room temperature sensor (QAA32), or external return air temperature sensor (QAH11.1) connected to multifunctional input X1 or X2.

Inputs X1 or X2 must be commissioned accordingly. See section 4.10.

Purge function

The changeover sensor ensures changeover from heating to cooling mode based on the acquired water temperature. We recommend activating the purge function (parameter P50) with 2-port valves. This function ensures correct acquisition of the medium temperature even if the 2-port valve is closed for an extended period of time. The valve is then opened for 1 to 5 minutes (adjustable) at 2-hour intervals during off hours. This function is available on all RDG variants for applications 2-pipe changeover and on RDG160T.. also for the 4-pipe changeover.



The purge function (parameter P50) must be disabled if the thermostat is used in compressor-based applications.

Avoid damage from moisture

In very warm and humid climates, the fan can be run periodically or continuously at a low fan speed (e.g. in empty apartments or shops) in Economy mode by setting parameter P61, in order to avoid damage from moisture due to lack of air circulation. See also section 4.9 for details.

Minimum output on-time/off-time

Limit the On/Off switching cycle to protect the compressor and reduce wear and tear. The minimum output on-time and off-time for On/Off control output can be adjusted from 1 to 20 minutes via parameters P48 and P49.

The factory setting is 1 minute.

Readjusting the setpoint or heating/cooling mode changeover immediately results in calculation of the output status; output Y11/Y21 may not hold the minimum 1-minute On/Off time.

If parameter P48 or P49 is set to above 1 minute, the minimum On/Off time for the control output is maintained as set, even if the setpoint or changeover mode is readjusted.

This function is only available for On/Off control with RDG100, RDG100T, RDG100T/H, RDG110.., and RDG160T..

**Floor heating/
Floor cooling**

All heating sequences can also be used for floor heating.

You can use fan coil heating/cooling sequences for floor heating or cooling by disabling the fan via parameter P52.

Floor temperature limitation function

The temperature should be limited for 2 reasons: comfort and protection of the floor.

The floor temperature sensor, connected to multifunctional input X1 or X2, acquires the floor temperature. If the temperature exceeds the parameterized limit (parameter P51), the heating valve is fully closed until the floor temperature drops to a level 2 K (4 °F) below the parameterized limit.

This function is factory-set to OFF (disabled).

Input X1 or X2 must be commissioned accordingly (P38 or P40 = 1).

See section 4.10 for details.

Recommended values for P51:

Living rooms:

Up to 26 °C (79 °F) for long-term presence, up to 28 °C (82 °F) for short-time presence.

Bath rooms:

Up to 28 °C (82 °F) for long-term presence, up to 30 °C (86 °F) for short-time presence.

The table below shows the relation between parameter, temperature source and temperature display:

Parameter P51	External temp. sensor available	Source for display of room temperature	Output control according to	Floor temp. limit function
OFF	No	Built-in sensor	Built-in sensor	Not active
OFF	Yes	External temp. sensor	External temp. sensor	Not active
10...50°C (50...122°F)	No	Built-in sensor	Built-in sensor	Not active
10...50°C (50...122°F)	Yes	Built-in sensor	Built-in sensor + limit by external sensor	Active

The floor temperature limitation function influences the outputs listed in the table below:

Application	Output Y1	Output Y2	Output Y3	Floor temp. limit function has influence on			Remark
				Heat. mode (P01=0/2/3)	Cool. mode (P01=1/2/3)	Heat. and cool. mode (P01=4)	
2-pipe	H/C valve			Y1	N/A		
2-pipe and electric heater	H/C valve	Electric heater		Y2	Y2 ¹⁾		Only electric heater
2-pipe and radiator	H/C valve	Radiator		Y2	Y2		Only radiator
4-pipe	Heating valve	Cooling valve		Y1	N/A	Y1	
4-pipe and electric heater	Heating valve	Cooling valve	Electric heater	Y3	N/A	Y3	Only electric heater
2-stage	1 st H/C	2 nd H/C		Y1, Y2	N/A		

¹⁾ If P13 = ON → electric heater in cooling mode

Note Either floor temperature sensor or external room temperature sensor can be used.

Supply air temperature limitation (RDG160T..)

This function increases the comfort in the room by keeping the supply air temperature of the fan coil unit between the selected minimum and maximum temperature limits. If the supply air temperature exceeds a limit, the thermostat reduces the corresponding valve position until the supply air temperature is back in the limits.

In case the air flow is too low (especially with DC 0...10 V fans), this prevents cold air from dumping into the room/warm air from bubbling straight up instead of circulating.

To enable this function, the multifunctional input, to which the supply air sensor is connected, needs to be set to "Supply air sensor" (e.g. P38=9). Then the parameters for the limits are visible (P63: minimum supply air temperature, P64: maximum supply air temperature).

This function is only active in Comfort mode and can only be used with DC 0...10 V actuators.

Note For applications with electric heater and radiator, this function is available only on the cooling valve (in cooling mode).

Dewpoint monitoring

Dewpoint monitoring is essential to prevent condensation on the chilled ceiling (cooling with fan disabled, parameter P52). It helps avoid associated damage to the building.

A dewpoint sensor with a potential-free contact is connected to multifunctional input X1, X2 or D1. If there is condensation, the cooling valve is fully closed until no more condensation is detected, and the cooling output is disabled temporarily.

The condensation symbol  is displayed during temporary override.

The input must be commissioned accordingly (P38, P40, P42).

See section 4.10.

Button lock

If the button lock function is enabled by parameter P14, the buttons will be locked or unlocked by pressing the right button for 3 seconds.

If "Auto lock" is configured, the thermostat will automatically lock the buttons 10 seconds after the last adjustment.

Operating mode switchover contact (window contact)

The thermostat can be forced into Economy mode (e.g. when a window is opened). The window contact can be connected to digital input D1 (or multifunctional input X1, X2). Set parameter P42 (P38, P40) to 3.

Extended Comfort mode (operating mode switchover contact closed)

The left button switches the operating mode from Economy to Comfort for the period preset in P68, if the following conditions are fulfilled:

- The operating mode switchover contact is closed (connected to input X1, X2, D1, parameter P38, P40, P42 set to 3)
- Parameter P68 (extend Comfort period) is greater than 0

During the temporary Comfort mode extension, sandglass symbol  appears.

If parameter P68 (extend Comfort period) = 0, extended Comfort cannot be activated; pressing the left button will show "OFF" (blinking 3 times).

Temporary timer for extension of presence/absence



The current operating mode can be forced temporarily into Comfort or Economy/Protection mode. The time period is adjusted via the rotary knob:

- Extend presence: Set the device to Comfort mode for the selected time period
- Extend absence: Set the device to Economy/Protection mode for the selected time period

To activate the function, keep the left button pressed and, within 3 seconds, turn the rotary knob...

- clockwise for extended presence
- counterclockwise for extended absence

The rotary knob adjusts the time period:

- Extend presence: 0.00...+9:30 in steps of 30 minutes; symbol  appears
- Extend absence: 0.00...-9:30 in steps of 30 minutes; symbol  or  appears

During the extended presence/absence period, sandglass symbol  appears.

Function without time program

User profile for operating mode (selected via P02)	Operating mode when activating function	Function	Operating mode during function	Operating mode at the end of function
P02 = 1: ☀️ 🏠	Comfort	Extension	Comfort	Protection
	Comfort	Absence	Protection	Comfort
P02 = 2: ☀️ 🏠	Comfort or Economy	Extension	Comfort	Economy
	Comfort or Economy	Absence	Economy	Comfort

Note Extension/Absence functions not available in protection mode

Function with time program (RDG100T, RDG100T/H, RDG160T..)

User profile for operating mode (selected via P02)	Operating mode when activating function	Function	Operating mode during function	Operating mode at the end of function
P02 = 1: 🕒 ☀️ 🏠	Auto or comfort	Extension	Comfort	Auto
	Auto or comfort	Absence	Protection	Auto
P02 = 2 → 🕒 ☀️ 🏠	Auto, Comfort or Economy	Extension	Comfort	Auto
	Auto, Comfort or Economy	Absence	Economy	Auto

Note Extension/Absence functions are not available in protection mode

4.6.1 Qx- relay switching functions (RDG160T.. only)

The following special functions are available on the RDG160T.. and allow the control of external equipment connected to the Q1, Q2 and Q3 relay outputs.

- Switch OFF external equipment when the thermostat is in Protection Mode
- Switch ON external equipment during heating/cooling demand
- Output heating/cooling sequence

The relay output corresponding parameters need to be set to enable the function.

- Function on Q1, set parameter P72. Test relay function via diagnostic d08.
- Function on Q2, set parameter P73. Test relay function via diagnostic d09.
- Function on Q3, set parameter P74. Test relay function via diagnostic d10.

Notes

- Those functions are available when DIP4 is set to OFF (EC fan).
- It is not suggested to use those functions in combination with the On/Off valve control (P46/P47=1) to guarantee the temperature accuracy. If this combination is requested, the total maximum current on the relay outputs (Q1+Q2+Q3) should not exceed 2A.

Switch OFF external equipment in Protection mode

The external equipment (such as: fan coil unit) can be switched OFF via relay output, in order to reduce energy consumption when the thermostat is in Protection mode and no temperature control is requested.

The function can be enabled by setting the corresponding Qx- parameter to 1. Relay contact is open when the thermostat is in protection mode.

Switch ON contact during Heat/Cool demand

During the heating or cooling demand, the relay contact can be energized to control an external equipment, for example to run the pump of a water system (fan coil).

To reduce the wear and tear of the HVAC equipment, the minimum output on-time and off-time of the Qx- relay output can be adjusted from 1 to 20 minutes via parameters P48 and P49. The factory setting is 1 minute.

Note

The relay output remains OFF if the heating is provided ONLY by electric heater (application 2-pipe electric heater, heating by electric heater, cooling by fan coil) or radiator.

2-pipe water system (with one pump):

- Enable the function by selecting the corresponding output parameter to 2
- Connect the external equipment to selected relay output
- In case of heating/cooling demand, the output contact is energized

4-pipe water system (with two pumps):

- The function can be enabled by selecting the correspondent output parameters > set one parameter to 3. The output is energized during heating demand > set one other parameter to 4. The output is energized during cooling demand
- Connect the external equipment to the selected relay outputs

Output heating/cooling sequence

This function switches the relay output depending on the sequence, either heating or cooling. The output can be used for the release of a heat pump compressor.

- When the thermostat is in heating mode (even in dead zone): > the correspondent Qx- output contact is closed.
- When the thermostat is in cooling mode (even in dead zone): > the correspondent Qx- output contact is open.

The function can be enabled by setting the corresponding Qx- parameter to 5.

4.7 Control sequences

4.7.1 Sequences overview (setting via parameter P01)

The sequence can be set via **parameter P01**.

The thermostats can be used in systems featuring:

- Heating only (P01 = 0)
- Cooling only (P01 = 1)
- Manual heating/cooling changeover (P01 = 2)
- Automatic heating/cooling changeover (P01 = 3)
- Heating and cooling mode (e.g. 4-pipe system) (P01 = 4)

The available modes depend on the application (selected via DIP switch, see section 4.5).

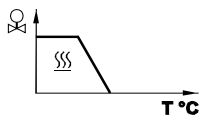
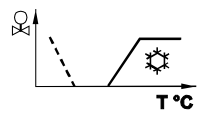
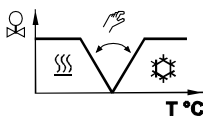
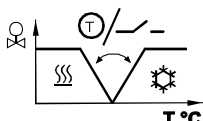
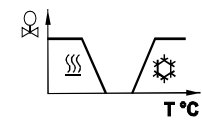
Parameter	P01 = 0	P01 = 1	P01 = 2	P01 = 3	P01 = 4
Sequence					
Mode	Heating mode	Cooling	Manually select heating or cooling sequence (using the button on the thermostat)	Automatic heating/cooling changeover via external water temperature sensor or remote switch	Heating and cooling mode, i.e. 4-pipe
Available for basic application ¹⁾ : ↓		\ = heating sequence for electric heater/radiator			
2-pipe, 2-pipe and electric heater 2-pipe and radiator	✓	✓	✓	✓	
4-pipe 4-pipe and electric heater			✓ ²⁾	✓ ²⁾	✓
2-stage heating or cooling	✓	✓	✓	✓	

Notes ¹⁾ Chilled/heated ceiling and radiator applications: see section 4.7.9;
Compressor applications: see section 4.7.10.

- ²⁾ Manual and automatic changeover for 4-pipe applications, see section 4.7.6:
- 4-pipe **manual** changeover (P01 = 2) means activating either cooling or heating outputs.
 - 4-pipe **automatic** changeover (P01 = 3) means swapping the control outputs according to a heating/cooling sensor or remote switch (main and secondary application), see section 4.7.6.

4.7.2 Control outputs configuration (setting via DIP switches 4/5 and parameters)

		Control outputs					
		On/Off (2-position)			Mod. PWM (2-pos.)	Mod. 3-pos.	Mod. DC 0...10 V
Fan control:		3-/1- speed	3-/1-speed	DC fan	3-/1-speed	3-/1-speed	3-/1-speed, DC fan
Applications	Type:	RDG10..	RDG110..	RDG160..	RDG10..	RDG10..	RDG160..
2-pipe		✓	✓	✓	✓	✓	✓
2-pipe and electric heater		✓	✓	✓	✓	✓	✓
2-pipe and radiator/floor heating		✓	✓	✓	✓	✓	✓
4-pipe		✓	✓	✓	✓	✓	✓
4-pipe and electric heater		✓			✓	(✓) *	
2 stage, cooling or heating		✓	✓	✓	✓	✓	✓

* Only possible for 1 actuator

RDG100..

With RDG100, RDG100T and RDG100T/H, the function of the control outputs (2-position or 3-position) is set via DIP switches 4 and 5.

The patterns of DIP switches 4 and 5 are as follows:

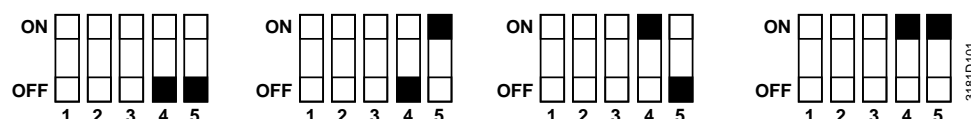

Y1/Y2 =	2-position	2-position	3-position	3-position
Y3/Y4 =	2-position	3-position	2-position	3-position

Note If 2-position is selected, the factory setting is On/Off. If you want PWM (pulse width modulation), set parameters P46 and/or P47 to 2 = PWM.

RDG110..

With RDG110.. only control output On/Off is available.

RDG160T..

With RDG160T.., the function of the control outputs (DC 0...10 V or 2-position) is set via parameters P46 and P47.

Control output 1	P46=2	DC 0...10V signal	Y10 terminal	Factory setting
	P46=1	2-position signal	Q1 terminal	
Control output 2	P47=2	DC 0...10V signal	Y20 terminal	Factory setting
	P47=1	2-position signal	Q2 terminal	

- Notes
- For applications with 3-speed fan, only DC 0...10 V control outputs on Y10, Y20 are available
 - Type of fan signal can be selected via P53 or DIP4, see section 4.9.
 - 2-position valve actuator control on applications without fan function – sequence of settings:
 - Set DIP 4 to Off and P53 = 3.
 - Disable the fan function via parameter P52 = 0
 - Set valve actuators to 2-position via P46 and/or P47 = 1

For details concerning connection of peripheral devices and setting of the DIP switches, refer to the Mounting Instructions:

- [4] M3181.1 (RDG100, RDG100T)

- [5] M3181.2 (RDG110)
- [6] M3181.5 (RDG160T)
- [7] M3181.4 (RDG100T/H)
- [9] M3183.1 (RDG110U)
- [10] M3183.2 (RDG160TU)

4.7.3 2-pipe fan coil unit

On 2-pipe applications, the thermostat controls a valve in heating/cooling mode with changeover (automatic or manual), heating only, or cooling only. Cooling only is factory set (P01 = 1).

On/Off control

Control sequence

On/Off output

The diagrams below shows the control sequence for 2-position control.

Heating mode

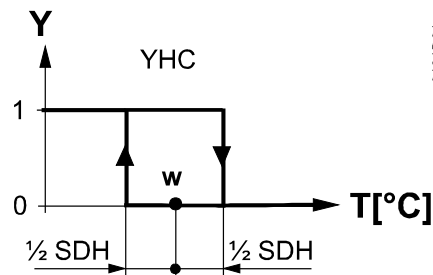

3191D01

Cooling mode

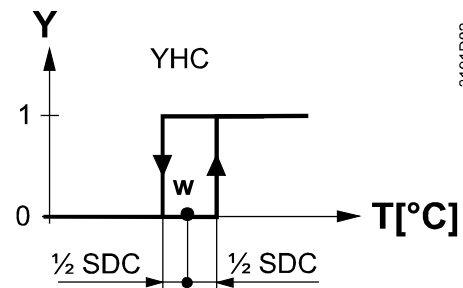

3191D02

T[°C] Room temperature

w Room temperature setpoint

YHC Control command "Valve" or "Compressor"

SDH Switching differential "Heating" (P30)

SDC Switching differential "Cooling" (P31)

Modulating control: 3-position, PWM or DC 0...10 V

Control sequence

modulating output

The diagrams below show the control sequence for modulating PI control.

Heating mode

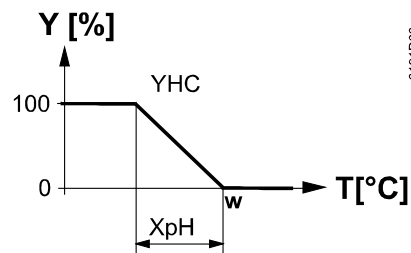

3191D03

Cooling mode

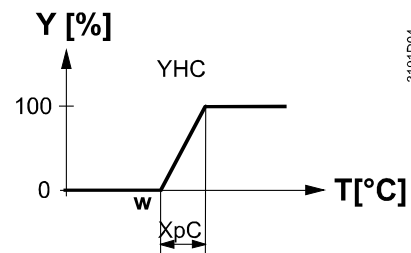

3191D04

T[°C] Room temperature

w Room temperature setpoint

YHC Control command "Valve"

XpH Proportional band "Heating" (P30)

XpC Proportional band "Cooling" (P31)

Note The diagrams only show the PI controller's proportional part.

Setting the sequence and the control outputs

Refer to section 4.5, 4.7.1 and 4.7.2.

4.7.4 2-pipe fan coil unit with electric heater

Heating or cooling with auxiliary heater

On 2-pipe applications with electric heater, the thermostat controls a valve in heating/cooling mode with changeover, heating only, or cooling only plus an electric heater.

Cooling only is factory set (P01=1) with enabled electric heater (P13).

Electric heating, active in cooling mode

In cooling mode, the valve receives an **OPEN** command if the acquired temperature is above the setpoint.

The electric heater receives an **ON** command if the acquired room temperature drops below "setpoint" minus "dead zone" (= setpoint for electric heater) while the electric heater is enabled (parameter P13 = on).

Note "Setpoint for electric heater" is limited by parameter "Maximum setpoint for Comfort mode" (P10).

Electric heating in heating mode

In heating mode, the valve receives an **OPEN** command if the acquired temperature is below the setpoint. The electric heater is used as an additional heating source when the heating energy controlled by the valve is insufficient.

The electric heater receives an **ON** command, if the temperature is below "setpoint" minus "setpoint differential" (= setpoint for electric heater).

Electric heating and manual changeover

The electric heater is active in heating mode only and the control output for the valve is permanently disabled when manual changeover is selected (P01=2).

Digital input "Enable electric heater"

Remote enabling/disabling of the electric heater is possible via input X1, X2 or D1 for tariff regulations, energy savings, etc.

Input X1, X2, or D1 must be commissioned accordingly (parameters P38, P40, P42). See section 4.10.

Caution ⚠

An electric heater must always be protected by a safety thermostat!

On/Off electric heater on RDG160T.. with ECM fan

- With a DC 0...10 V (ECM) fan it is possible to select On/Off control for the electric heater by setting parameter P47 = 1. The electric heater has to be connected to output Q2.
- The electric heater starts with a delay of 15 s, to make sure the fan delivers sufficient air flow to dissipate the heat.
- To avoid overheating of the electric heater, the thermostat guarantee at least a fan speed II (middle value between Vmin (P56) – Vmax (P55)) when the electric heater need to be energized.
- Adaptive temperature compensation P45 need to be set accordingly (Refer to section 4.8).

On/Off control

Control sequence On/Off output

The diagrams below show the control sequence for 2-position.

Heating mode

(automatic changeover = heating or heating only)

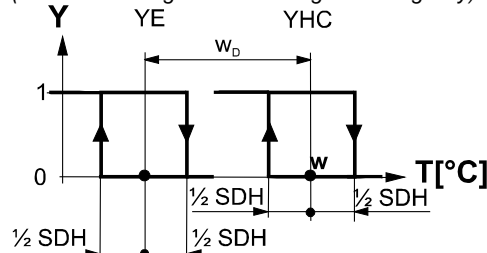

Cooling mode

(man./auto. changeover = cooling or cooling only)

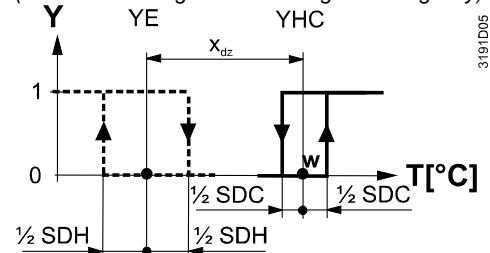

Heating mode with manual changeover (P01=2)) on RDG100.. and RDG110..

(manual changeover = heating)

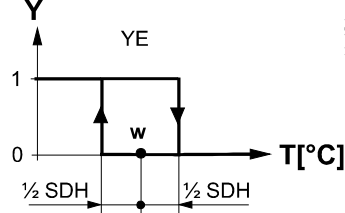

3076D07

- T[°C] Room temperature
- W Room temperature setpoint
- YHC Control command "Valve" or "Compressor"
- YE Control command "Electric heater"
- SDH Switching differential "Heating" (P30)
- SDC Switching differential "Cooling" (P31)
- X_{dz} Dead zone (P33)
- w_D Setpoint differential (P34)

- Note
- RDG160T.. with manual changeover works in the same way as for automatic changeover, with 2-stage heating.

Modulating control 3-position, PWM or DC 0...10 V

Control sequence
modulating output

The diagrams below show the control sequence for modulating control.

Heating mode

(automatic changeover = heating or heating only)

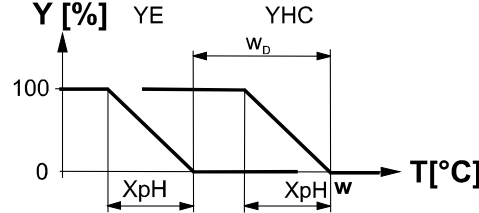

3191D09

Cooling mode

(man. /auto. changeover = cooling or cooling only)

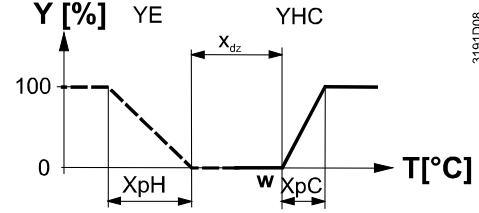

3191D08

Heating mode with manual changeover (P01=2) on RDG100.. and RDG110..

(manual changeover = heating)

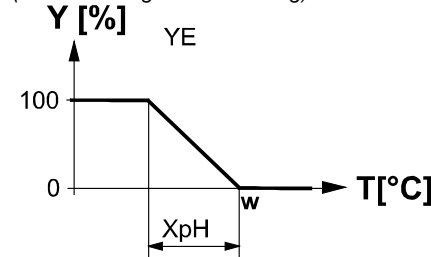

3076D10

- T[°C] Room temperature
- W Room temperature setpoint
- YHC Control command "Valve"
- YE Control command "Electric heater"
- XpH Proportional band "Heating" (P30)
- XpC Proportional band "Cooling" (P31)
- X_{dz} Dead zone (P33)
- w_D Setpoint differential (P34)

- Note
- The diagrams only show the PI controller's proportional part.
 - RDG160T.. with manual changeover works in the same way as for automatic changeover, with 2-stage heating.

Setting the sequence and the control outputs

Refer to section 4.5, 4.7.1 and 4.7.2.

4.7.5 2-pipe fan coil unit with radiator or floor heating

Heating or cooling with radiator or floor heating

On 2-pipe applications with radiator, the thermostat controls a valve in heating/cooling mode with changeover, heating only, or cooling only plus a radiator valve. Cooling only is factory-set (P01=1).

Radiator, active in cooling mode

In cooling mode, the valve receives an **OPEN** command if the acquired temperature is above the setpoint.

The radiator receives an **ON** command if the acquired room temperature drops below "setpoint" minus "dead zone" (= "setpoint for radiator").

Radiator in heating mode

In heating mode, the radiator receives an **OPEN** command if the acquired temperature is below the setpoint. The fan coil unit is used as an additional heat source when the heat energy controlled by the radiator is insufficient.

The fan coil unit receives an **ON** command if the temperature is below "setpoint" minus "setpoint differential" (= setpoint for fan coil unit).

Floor heating

The radiator sequence can also be used for floor heating.

The "Floor heating limitation function" is described on page 20.

On/Off control

The diagrams below show the control sequence for 2-position control.

Heating mode

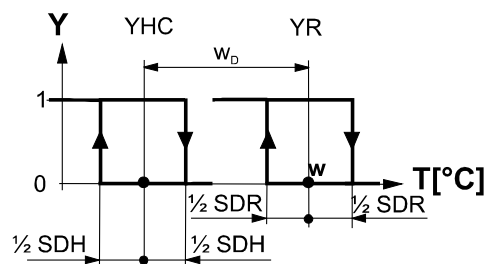

Cooling mode

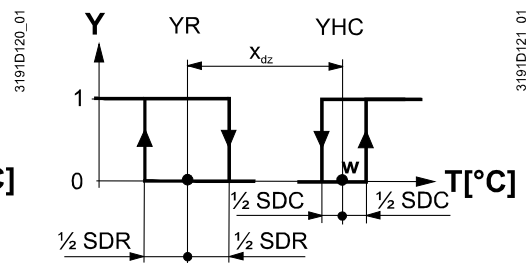

T[°C] Room temperature
W Room temperature setpoint
YHC Control command "Valve" or "Compressor"
YR Control command "Radiator"

SDH Switching differential "Heating" (P30)
SDC Switching differential "Cooling" (P31)
X_{dz} Dead zone (P33)
w_D Setpoint differential (P34)

Modulating control: 3-position, PWM or DC 0...10 V

The diagrams below show the control sequence for modulating PI control.

Heating mode

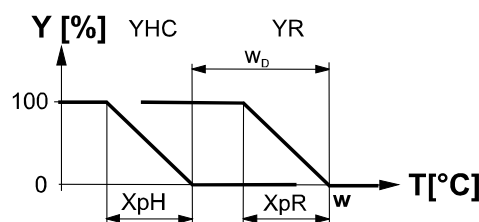

Cooling mode

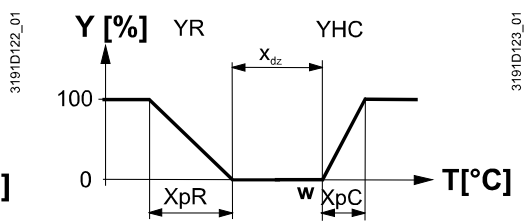

T[°C] Room temperature
W Room temperature setpoint
YHC Control command "Valve"
YR Control command "Radiator"

X_{pH} Proportional band "Heating" (P30)
X_{pC} Proportional band "Cooling" (P31)
X_{dz} Dead zone (P33)
w_D Setpoint differential (P34)

Note The diagrams only show the PI controller's proportional part.

Setting the sequence and the control outputs

Refer to section 4.5, 4.7.1 and 4.7.2.

4.7.6 4-pipe fan coil unit

Heating and cooling

On 4-pipe applications, the thermostat controls 2 valves in heating and cooling mode, heating/cooling mode by manual selection, or heating and cooling mode with changeover. Heating and cooling mode (P01=4) is factory-set.

4-pipe application with manual changeover

The heating or cooling output can be released via operating mode button if parameter P01 is set to manual (P01=2).

"Main and secondary" application (4-pipe with changeover)

If parameter P01 is set to changeover (P01=3), the heating and cooling output is swapped according to the changeover sensor input status (see automatic heating and cooling changeover sensor, section 4.6). This mode is used for the so-called "Main and secondary" application. This is a 4-pipe fan coil unit system with different capacity of the 2 coils. The water circuit is changed to optimize the energy exchange depending on the season (summer/winter):

- Winter: Large coil (V1) for heating, small coil (V2) for cooling
- Summer: Large coil (V1) for cooling, small coil (V2) for heating

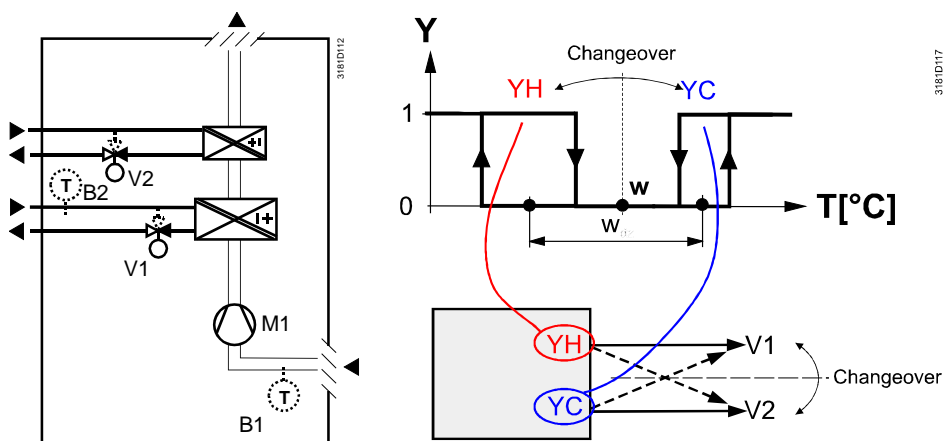

Note:
This example shows On/Off control; for modulating control, connect the appropriate output terminals.

- Notes
- The factory setting for the heating and cooling changeover sensor (B2 in the above diagram) is input X2 (P40 = 2)
 - The thermostat assumes winter operation when $B2 > P37$ (factory setting 28 °C (82 °F))
 - The thermostat assumes summer operation when $B2 < P36$ (factory setting 16 °C (61 °F))

On/Off control

The diagrams below show the control sequence for 2-position control.

Heating mode with manual selection (P01=2) or for P09 >= P10 in heating sequence ^{*)}

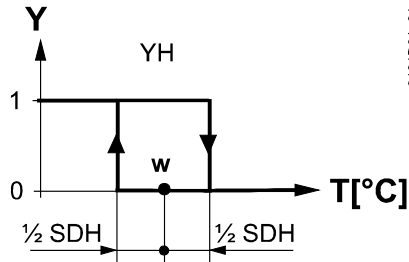

Cooling mode with manual selection (P01=2) or for P09 >= P10 in cooling sequence ^{*)}

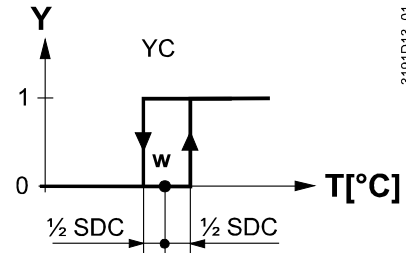

Heating and cooling mode (P01=04)

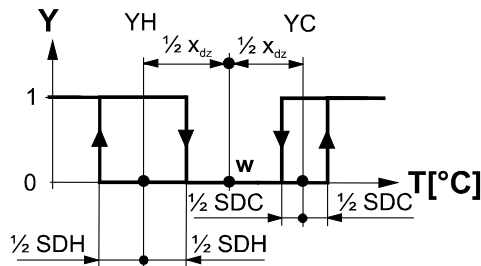

T[°C] Room temperature
w Room temperature setpoint
YH Control command "Valve" (heating)
YC Control command "Valve" (cooling)
SDH Switching differential "Heating" (P30)
SDC Switching differential "Cooling" (P31)
X_{dz} Dead zone (P33)

Modulating control: 3-position or PWM

The diagrams below show the control sequence of modulating PI control.

Heating mode with manual selection (P01=2) or for P09 >= P10 in heating sequence ^{*)}

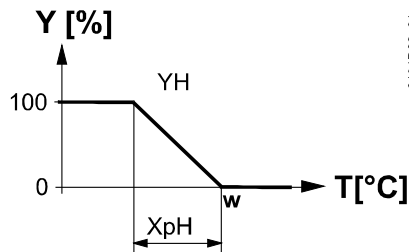

Cooling mode with manual selection (P01=2) or for P09 >= P10 in cooling sequence ^{*)}

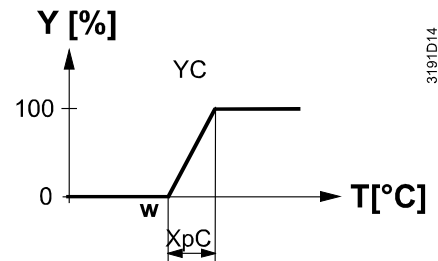

Heating and cooling mode (P01=04)

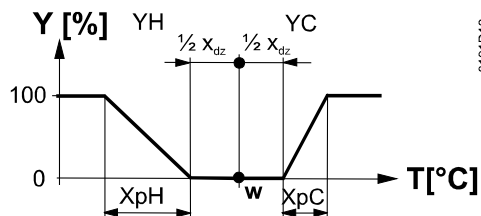

T[°C] Room temperature
w Room temperature setpoint
YH Control command "Valve" (heating)
YC Control command "Valve" (cooling)
XpH Proportional band "Heating" (P30)
XpC Proportional band "Cooling" (P31)
X_{dz} Dead zone (P33)

^{*)} see section 4.3.

Note The diagrams only show the PI controller's proportional part.

Setting the sequence and the control outputs

Refer to section 4.5, 4.7.1 and 4.7.2.

4.7.7 4-pipe fan coil unit with electric heater (RDG100..)

Heating and cooling with auxiliary heater

On 4-pipe applications with electric heater, the thermostat controls 2 valves in heating and cooling mode by manual selection, heating and cooling mode with automatic changeover, heating only, or cooling only plus an electric heater. Heating and cooling is factory-set (P01=4).

Electric heating in heating mode

The electric heater is used as an additional heat source when the heating energy controlled by the valve is insufficient. The electric heater receives an **ON** command when the temperature is below "setpoint" minus "1/2 dead zone" minus "setpoint differential" (= "setpoint for electric heater").

Digital input "Enable electric heater"

Remote enabling/disabling of the electric heater is possible via input X1, X2, or D1 for tariff regulations, energy saving, etc. Input X1, X2, or D1 must be commissioned accordingly (parameters P38, P40, P42). See section 4.10 for details.

Caution

An electric heater must always be protected by a safety thermostat!

4-pipe application with manual changeover

The heating or cooling output can be released via operating mode button if parameter P01 is set to manual (P01=2).

"Main and secondary" application

See section 4.7.6 for details.

On/Off control

The diagrams below show the control sequence for 2-position control.

Heating mode with **manual** selection (P01=2)

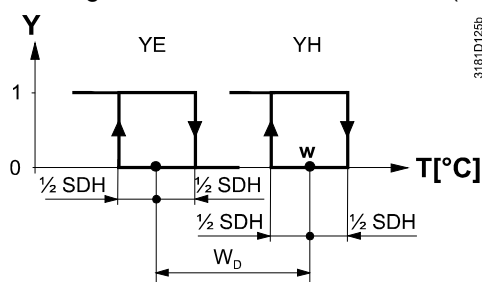

Cooling mode with **manual** selection P01=2

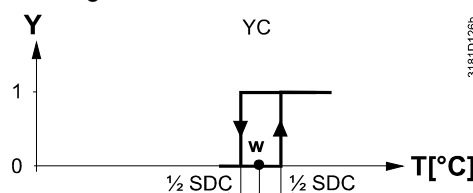

Heating and cooling mode (P01=4)

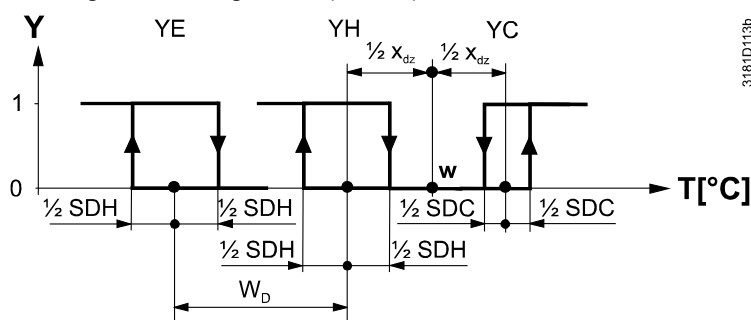

- T[°C] Room temperature
- w Room temperature setpoint
- YE Control command "Electric heater"
- YH Control command "Valve" or "Comp." (H)
- YC Control command "Valve" or "Comp." (C)
- SDH Switching differential "Heating" (P30)
- SDC Switching differential "Cooling" (P31)
- X_{dz} Dead zone (P33)
- w_D Setpoint differential (P34)

Modulating control: 3-position or PWM

The diagrams below show the control sequence of modulating PI control.

Heating mode with manual selection (P01=2)

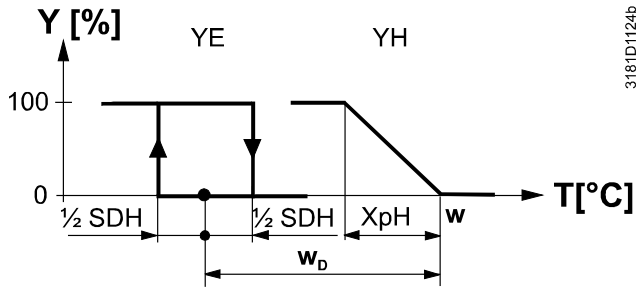

Cooling mode with manual selection P01=2)

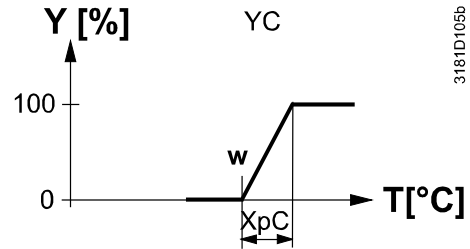

Heating and cooling mode (P01=4)

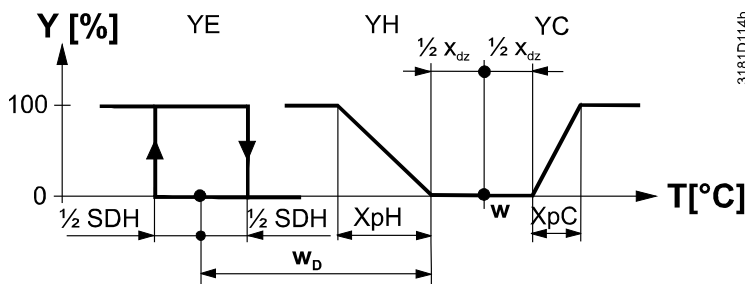

T[°C] Room temperature

w Room temperature setpoint

YE Control command "Electric heater"
(only On/Off)

YH Control command "Valve" or "Comp." (H)
(only PWM, not 3-position)

YC Control command "Valve" or "Comp." (C)

X_{pH} Proportional band "Heating" (P30)

X_{pC} Proportional band "Cooling" (P31)

X_{dz} Dead zone (P33)

w_D Setpoint differential (P34)

Note The diagrams only show the PI controller's proportional part.

Setting the sequence and the control outputs

Refer to section 4.5, 4.7.1 and 4.7.2.

- Notes
- YH can only be On/Off or PWM
 - YC can be On/Off, PWM or 3-position
 - YE can only be On/Off

4.7.8 2-stage heating or cooling

2-stage heating or cooling

On 2-stage applications, the thermostat controls 2 valves or compressors in heating or cooling mode or changeover (automatic or manual).

"Cooling only" is factory-set (P01=1).

Heating mode

In heating mode, the 1st stage is activated if the acquired temperature is below the setpoint.

The 2nd stage is activated if the acquired room temperature drops below "setpoint" minus "setpoint differential".

Cooling mode

In cooling mode, the 1st stage is activated if the acquired temperature is above the setpoint.

The 2nd stage is activated if the acquired room temperature rises above "setpoint" plus "setpoint differential".

On/Off control

The diagrams below show the control sequence for 2-position control.

Heating mode (P01=0)

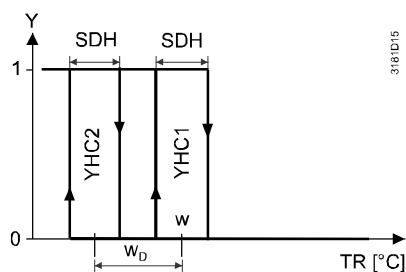

Cooling mode P01=1)

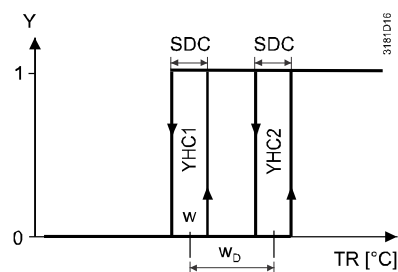

Changeover (P01=2 or P01=3)

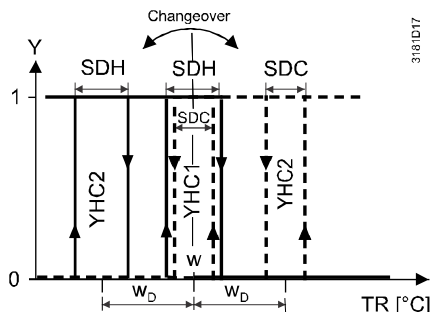

T[°C] Room temperature

w Room temperature setpoint

YHC1 Control command "Stage 1"

YHC2 Control command "Stage 2"

SDH Switching differential "Heating" (P30)

SDC Switching differential "Cooling" (P31)

X_{dz} Dead zone (P33)

w_D Setpoint differential (P34)

Modulating control: 3-position, PWM or DC 0...10 V

The diagrams below show the control sequence of modulating PI control.

Heating mode (P01=0)

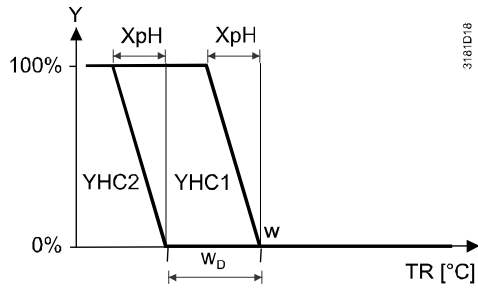

Cooling mode P01=1)

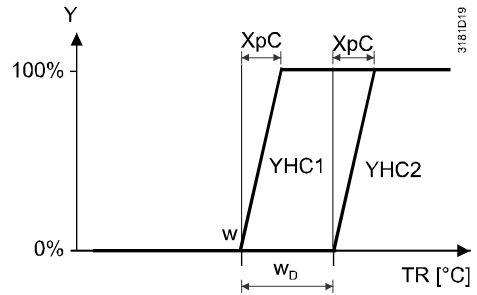

Changeover (P01=2 or P01=3)

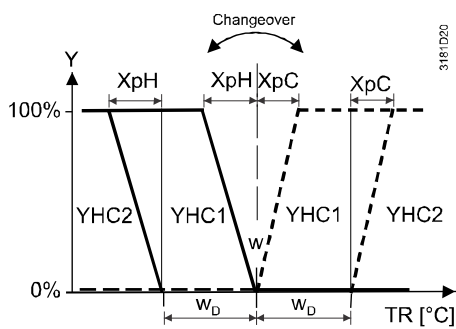

T[°C] Room temperature

w Room temperature setpoint

YHC1 Control command "Stage 1"

YHC2 Control command "Stage 2"

XpH Proportional band "Heating" (P30)

XpC Proportional band "Cooling" (P31)

X_{dz} Dead zone (P33)

w_D Setpoint differential (P34)

Note The diagrams only show the PI controller's proportional part.

Setting the sequence and the control outputs

Refer to section 4.5, 4.7.1 and 4.7.2.

4.7.9 Chilled/heated ceiling and radiator applications

For chilled/heated ceiling and radiator,

- set the corresponding basic application
- disable the fan (P52)

The following applications are available:

Application for chilled/heated ceiling, radiator	Set basic application	See section	Sequences
Chilled/heated ceiling with changeover	2-pipe	4.7.3	H (\) C (/)
Chilled/heated ceiling and electric Heater (cooling only: disable electric heater via P13)	2-pipe and electric heater	4.7.4	El. H + H (↔ \) El. H + C (↔ /) C (/)
Chilled/heated ceiling and radiator	2-pipe and radiator	4.7.5	H + rad (\ r) Rad + C (r /)
Chilled ceiling and radiator	4-pipe	4.7.6	H + C (\ /)
Chilled/heated ceiling, 2-stage	2-stage heating or cooling	4.7.8	H + H (\ \) C + C (//)

Refer to section 4.5.2 for details about the product type and control outputs.

4.7.10 Compressor applications (general)

For compressor applications,

- set the corresponding basic application
- disable the fan (P52) or set the fan speed (P53)

The following applications are available:

Application for chilled/heated ceiling, radiator	Set basic application	See section	Sequences	RDG110 RDG110U	RDG160T RDG160TU
1-stage compressor	2-pipe	4.7.3	H (\) C (/)	✓	✓
1-stage compressor and electric heater (cooling only: disable electric heater via P13)	2-pipe and electric heater	4.7.4	El. H + H (↔ \) El. H + C (↔ /) C (/)	✓	✓
1-stage compressor for heating and cooling	4-pipe	4.7.6	H + C (\ /)	✓	✓
1-stage compressor with reversing valve (for details, see below)	4-pipe	4.7.6	H + C (\ /)	✓	-
2-stage compressor	2-stage heating or cooling	4.7.8	H + H (\ \) C + C (//)	✓	✓

- Notes
- Minimum On/Off time: P48/P49
 - Fan operation: P52 (0 = disabled, 1 = enabled)
 - Fan speed: P53 (1 = 1-speed, 2 = 3-speed)

Refer to section 4.5.3 for details about the product type and control outputs.

4.7.11 1-stage heating or cooling with reversing valve (RDG110..)

On this application, the thermostat controls a compressor in heating or cooling mode with changeover (automatic or manual). Cooling only is factory-set (P01=1).

- Set basic application "4-pipe" (see section 4.7.6)
- Connect compressor and reversing valve as follows:

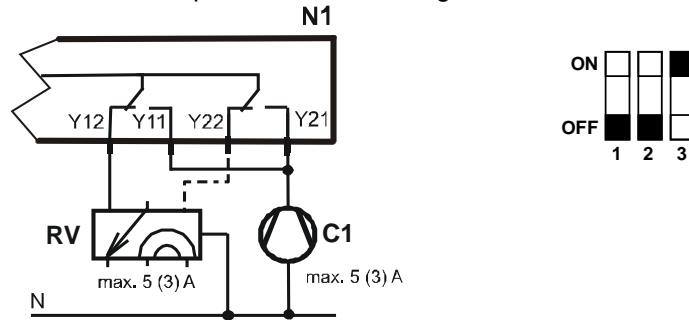

Hardware

This application is available with RDG110.. only.

On/Off control

The diagrams below show the control sequences for 2-position control.

Heating mode with manual selection
(P01 = 2)

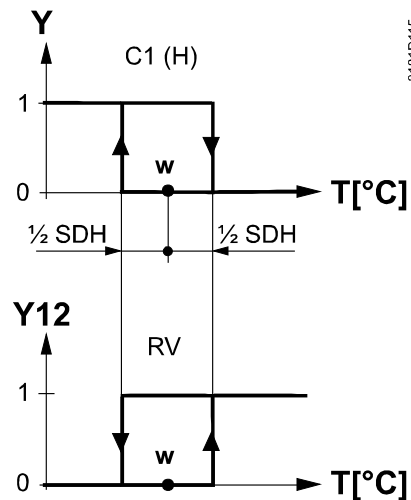

Cooling mode with manual selection
(P01 = 2)

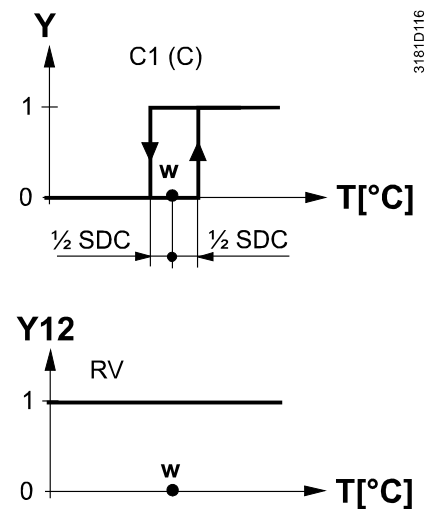

Heating and cooling mode (P01=04)

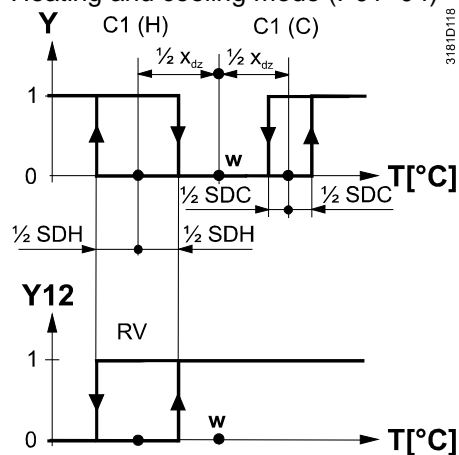

T [°C] Room temperature

w Room temperature setpoint

Y11 Control command "Compressor" (H)

Y21 Control command "Compressor" (C)

Y12 Control command "Reversing valve"
(heating = ON)

SDH Switching differential "Heating" (P30)

SDC Switching differential "Cooling" (P31)

X_{dz} Dead zone (P33)

4.8 Control outputs

Overview of control outputs

Different control output signals are available depending on the thermostat type, the position of DIP switches 4 and 5, and parameters P46 and P47 (see section 4.7.2).

Control output	On/Off	PWM	3-position	DC 0...10 V
Product no.				
RDG100 RDG100T RDG100T/H	Y1, Y2, Y3 (3 x N.O.)	Y1, Y3, (2 x PWM)	Y1/Y2, Y3/Y4 (2 x ▲/▼)	
RDG110 RDG110U	Y11/Y12, Y21/Y22 (2 x SPDT)			
RDG160T RDG160TU	Q1, Q2 (2 x N.O.)			Y10, Y20 (2 x DC 0...10 V)

On/Off control signal (2-position)

The valve or compressor receives the **ON** command via control output Y1 or Y3 (RDG110..: Y11/Y21, RDG160T..: Q1/Q2) when

1. the acquired room temperature is below the setpoint (heating mode) or above the setpoint (cooling mode).
2. the control outputs have been inactive for more than the "Minimum output off-time" (factory setting 1 minute, adjustable via parameter P48).

OFF command when

1. the acquired room temperature is above the setpoint (heating mode) or below the setpoint (cooling mode).
2. the valve has been active for more than the "Minimum output on-time" (factory setting 1 minute, adjustable via parameter P49).

Electric heater control signal (On/Off)

The electric heater receives an **ON** command via the auxiliary heating control output (Y.., see Mounting Instructions) when

1. the acquired room temperature is below "Setpoint for electric heater"
2. the electric heater has been switched off for at least 1 minute

The **OFF** command for the electric heater is output when

1. the acquired room temperature is above the setpoint (electric heater)
2. the electric heater has been switched on for at least 1 minute

Caution

A safety thermostat (to prevent overtemperatures) must be provided externally.

Note!

On RDG160T.. the electric heater can be controlled via the 2-position output (Q2) by setting P47 = 1.

Adaptive temperature compensation for electric heater (RDG160T.., RDG110..)

When an electric heater is connected directly to the On/Off output (RDG160T..: Q2, RDG110..:Y21), the current causes the relay contact to heat up. This falsifies the reading of the internal temperature sensor. The thermostat compensates the temperature if the rated current/power of the electric heating is entered in the parameters.

RDG160T..:

P45 (power electric heater): Factory setting: 0.0 kW, setting range: 0.0...1.2 kW.

RDG110:

P46 (load current electric heater): Factory setting: 1 A, setting range: 1...5 A.

RDG110U:

P46 is not available for AC 24 V operating voltage with electric heater controlled via external relay.

3-position control signal

This function is available with RDG100, RDG100T and RDG100T/H only.

Heating: Output Y1 provides the **OPEN** command, and Y2 the **CLOSE** command to the 3-position actuator. Relay function Y1/Y2 and wiring can be tested via diagnostic parameter d05. Cooling: Idem with Y3 and Y4. Relay function Y3/Y4 and wiring can be tested via diagnostic parameter d06.

The factory setting for the actuator's running time is 150 seconds. It can be adjusted via parameters P44 (Y1 and Y2) or P45 (Y3 and Y4).

The parameters are only visible if 3-position is selected via DIP switches 4 and 5.

Synchronization

1. When the thermostat is powered up, a closing command for the actuator running time + 150% is provided to ensure that the actuator fully closes and synchronizes to the control algorithm.
2. When the thermostat calculates the positions "fully close" or "fully open", the actuator's running time is extended + 150% to ensure the right actuator position is synchronized to the control algorithm.
3. After the actuator reaches the position calculated by the thermostat, a waiting time of 30 seconds is applied to stabilize the outputs.

PWM control

This function is available with RDG100, RDG100T and RDG100T/H only.

The demand calculated by PI control from the current room temperature and setpoint is provided via Y1 and Y3 to the valve actuator as a PWM signal (pulse width modulation) for thermal actuators. The output is activated for a period proportional to the heating/cooling demand and then switched off for the rest of the PWM interval.

The interval is 150 seconds (factory setting). It can be adjusted via parameters P44 (Y1) or P45 (Y3). These parameters are only visible if 2-position is selected via DIP switches 4 and 5 and if PWM is selected via P46 and P47.

Note! For PWM, the **integral time (P35) must be set to 0.**

PWM for thermal valve actuators

For thermal valve actuators, set the running time to 240 seconds.

- Note!**
- Never apply PWM to an electromotoric actuator.
 - It is not possible to ensure exact parallel running of 2 or more thermal valve actuator. If several fan coil units are driven by the same thermostat, preference should be given to electromotoric actuators with On/Off or 3-position position control.

PWM for electric heaters

For electric heaters, set the running time to 90 seconds.

To avoid burn-off of mechanical contacts by frequent switching, use a current valve in place of a relay or contactor.

Note! For PWM, the **integral time (P35) must be set to 0.**

DC 0...10 V control

This function is available with RDG160T.. only.

DC 0...10 V
for valve actuators

The demand calculated by PI control from the current room temperature and setpoint is provided via Y10 and Y20 to the valve actuator as a continuous DC 0...10 V signal.

DC 0...10 V
for electric heaters

For applications with 3-speed fan, the electric heater can be controlled only via DC output.

- The demand calculated by PI control from the current room temperature and setpoint is provided via Y20 as a continuous DC 0...10 V signal.
- The signal converter (SEM61.4) converts the DC 0...10 V signal to AC 24 V PDM pulses for the current valve.
- The current valve (SEA45.1) supplies the electric heater with AC 50...660 V pulsed current.

Note! For applications with ECM fan (DC signal) on RDG160T.., the electric heater can be controlled via the On/Off output (Q2) by setting P47 = 1.
Adaptive temperature compensation: see 4.7.4.

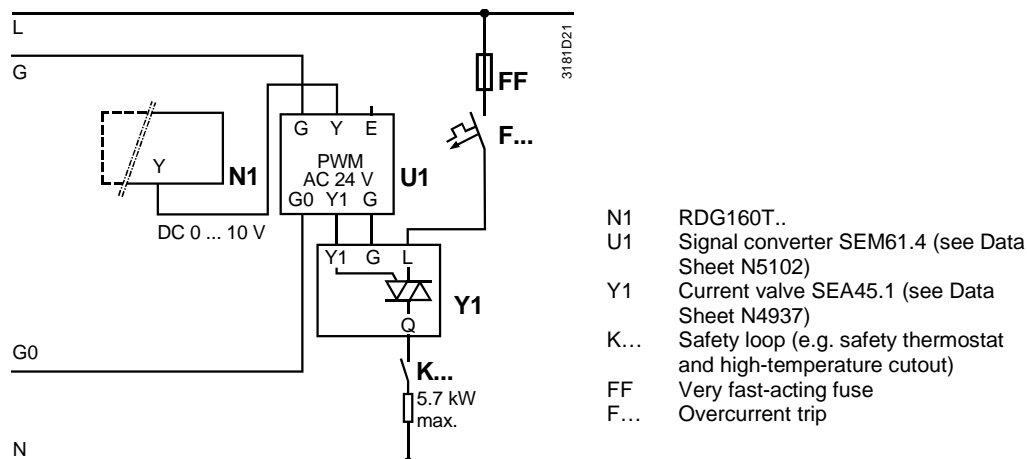

4.9 Fan control

Overview of fan outputs

Different fan output signals are available depending on the thermostat type:

Control output Product no.	2 On/Off 1-/3-speed fan	Modulating fan DC 0...10 V	Control type selected via
RDG100, RDG100T, RDG100T/H	Q1,Q2,Q3 (3)		P53
RDG110..	Q1,Q2,Q3 (3)		P53
RDG160T..	Q1,Q2,Q3 (3) ¹⁾	Y50 (1) ¹⁾	P53, DIP 4

() Number of outputs

¹⁾ Selectable via P53 or DIP switch 4 on RDG160T..

The fan operates in automatic mode or at the selected speed with manual mode. In automatic mode, the fan speed depends on the setpoint and the current room temperature. When the room temperature reaches the setpoint, the control valve closes and the fan switches off or stays at fan speed I (minimum fan speed) according to the setting of parameters P15 and P60.

Factory setting for "Fan in the dead zone":

- Fan speed OFF: P15 = 0, P60 = OFF.

Only one fan output at a time is on, either Q1, Q2 or Q3.

Selection fan output on RDG160T..

The type of the fan output (DC 0...10 V, 3-speed or 1-speed) can be set via DIP switch 4, local HMI (P53).

If application is set via DIP switches and DIP 4 = Off:

- DC 0...10 V fan (ECM) on Y50 is selected
- Parameter P53 = 3 (ECM fan) cannot be modified
- 1-speed/3-speed fan output is not selectable

If application is set via DIP switches and DIP 4 = On

- 3-speed fan on Q1, Q2, Q3 is selected, parameter P53 = 2
- 1-speed fan (on Q1) can be selected via HMI (P53 = 1)
- DC 0...10 V (ECM) fan output is not selectable
- 3-speed fan output is enabled only if the application has also been selected

3-speed fan control with modulating heating/cooling control (PWM, 3-pos or DC 0...10 V)

The individual switching points for **ON** of each fan stage can be adjusted via control parameters P55...P57. The fan speed switch off point is 20% below the switch on point. The diagrams below show fan speed control for modulating PI control.

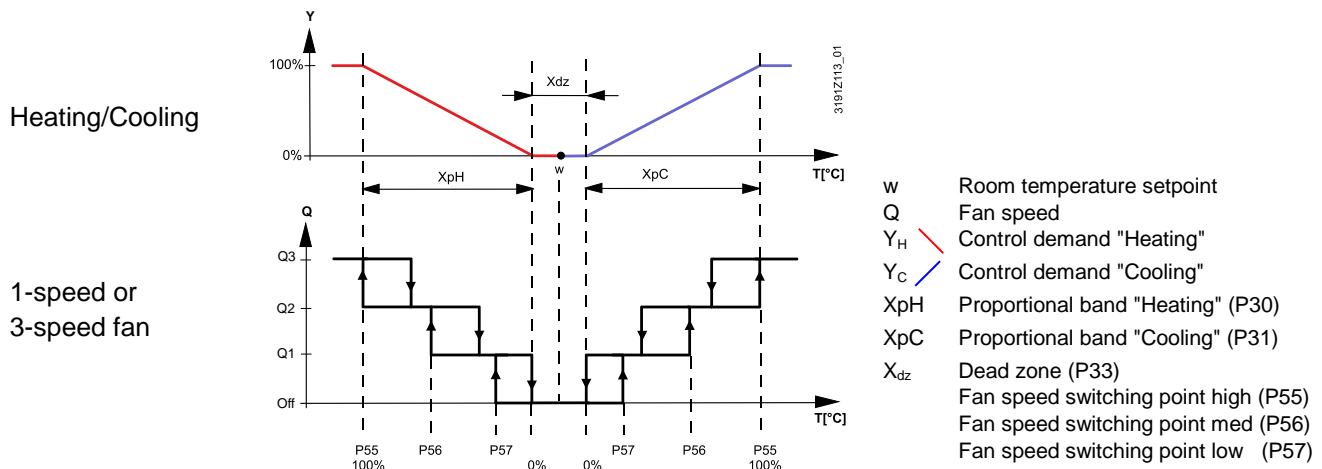

Note The diagram only shows the PI control's proportional part.

3-speed/ECM fan control with On/Off heating/cooling control

On applications with 2-position control:

- 1) The switching point for low fan speed is synchronized to the heating/cooling output. Parameter "Switching point fan speed low" P57 is not relevant.
- 2) The maximum switching range of the fan ($X_{pH_{Fan}}/X_{pC_{Fan}}$) is defined by the switching differential (SDH/SDC) via a look-up table.

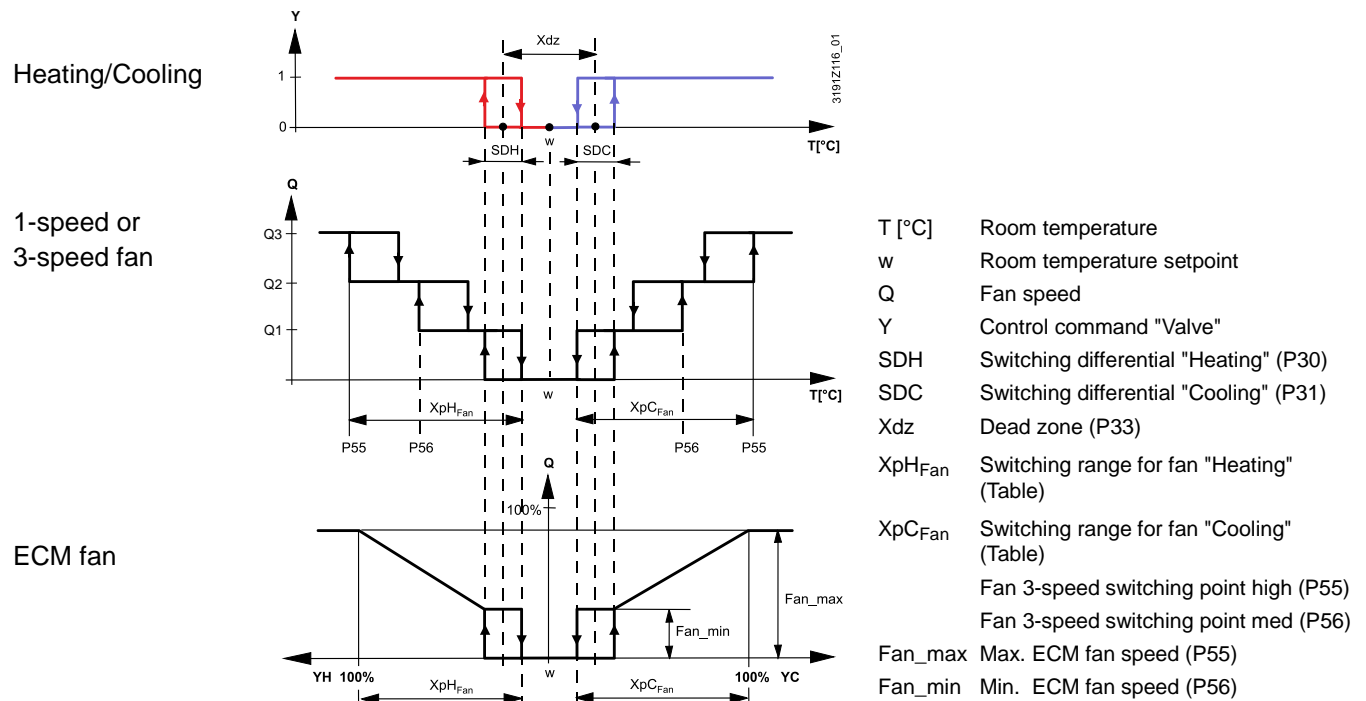

Look-up table with On/Off control

SDH/SDC [K]	0.5	1.0	1.5	2.0	2.5	3.0	3.5	4.0	>4.5
$X_{pH_{Fan}}/X_{pC_{Fan}}$ [K]	2	3	4	5	6	7	8	9	10

1-speed/3-speed fan

The thermostat can control a 1-speed or 3-speed fan (selected via control parameter P53).
A 1-speed fan is connected to terminal Q1, a 3-speed fan to terminals Q1, Q2 and Q3.

Control sequence for DC 0...10 V fan (ECM) and DC 0...10 V valves (RDG160T..)

When DC 0...10 V Fan and DC 0...10 V valve output control is selected, the fan switching points can be set via the following parameters:

- P55: ECM fan max. output
- P56: ECM fan min. output
- P57: Switching point fan

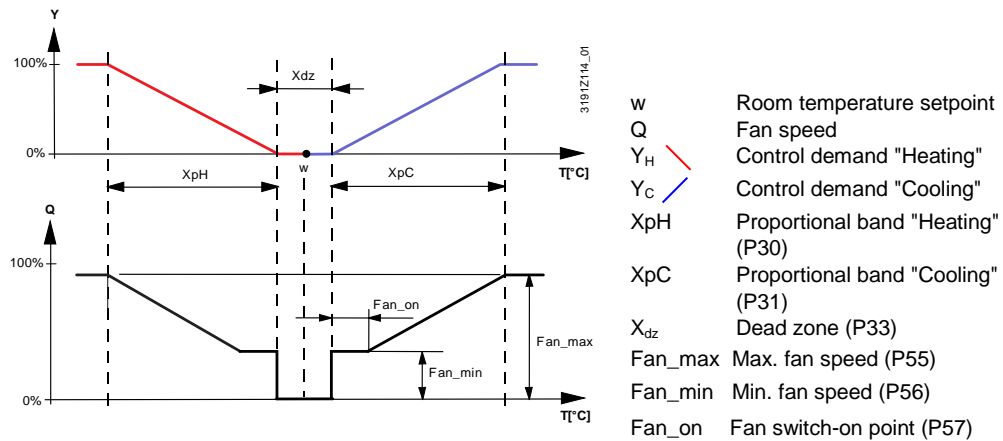

Note The diagram only shows the PI control's proportional part.

Manual operation DC 0...10 V fan

Fan speed 4-I = Min. fan speed
Fan speed 2-II = half-way between min. fan speed and max. fan speed
Fan speed 3-III = Max. fan speed

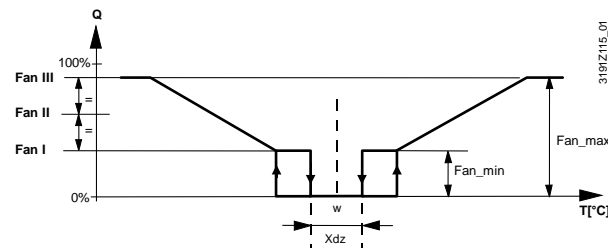

Note: The control signals "Heating" and "Cooling" are not influenced by the manual setting of fan speeds.

Note By heating only with electric heater, manual fan speed 4-I cannot be selected to guarantee the necessary minimum air flow for the electric heater and to avoid overheating of the system.

2 sequences heating/cooling

For heating or cooling with 2 sequences (e.g. heating with a heating coil and an electric heater, or 2-stage cooling), the fan is always synchronized with the first sequence.

Fan operation as per heating/cooling mode, or disabled

Fan operation can be limited to be active with cooling only or heating only, or even be totally disabled via control parameter "Fan operation" P52.
When fan operation is disabled, the fan symbol on the display disappears and pressing the fan button has no impact.
This function allows you to use the thermostat on universal applications such as chilled/heated ceilings and radiator, etc. (see section 4.7.9).

Fan minimum on-time

In automatic mode, a dwelling time of 2 minutes (factory setting) is active. The fan maintains each speed for at least 2 minutes before it changes to the next speed. This minimum on-time can be adjusted from 1...6 minutes via parameter P59.

Fan kick P60, P61

In automatic fan mode and with the room temperature in the dead zone, the control valve is normally closed and the fan disabled. With the "Fan kick" function, the fan can be released from time to time at low speed for minimum on-time (see above) even if the valve is closed.

This function can be used to avoid damage from moisture due to a lack of air circulation, or to allow a return air temperature sensor to acquire the correct room temperature.

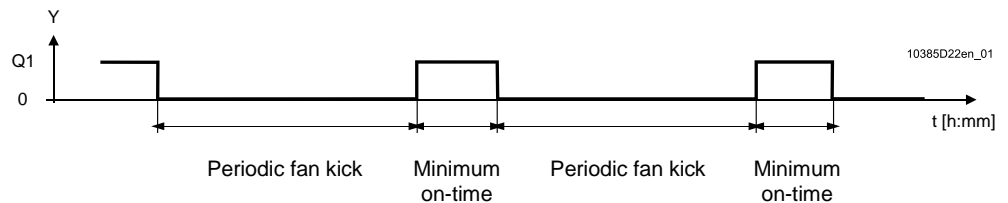

The periodic fan kick time can be selected individually for Comfort mode via parameter P60, and for Economy mode via parameter P61.

- Note
- Fan kick value "0" means the fan runs continuously in the dead zone.
 - Fan kick value "1" and higher: value in minutes
 - Fan kick value "OFF" means the fan does not run in the dead zone.

Fan operation in dead zone P15

Via parameter P15 in "Service Level", the fan speed in the dead zone (in Comfort mode) can be set according to customer preference.

The following options are available:

- Fan does not run in the dead zone (P15=0)
- Fan runs at low speed in Heating and Cooling mode (P15=1)
- Fan runs at low speed in Cooling mode only (P15=2)

The functions "Fan in dead zone" (P15) and "Fan kick" (P60) are combined as follows:

- P60 = 0 Fan runs continuously in the dead zone, P15 has no influence
- P60 = OFF Fan operation in dead zone according to P15

Fan start

When the fan starts from standstill, it starts at speed 3-III for 1 second to ensure safe fan motor start by overcoming inertia and friction (selected via parameter P58).

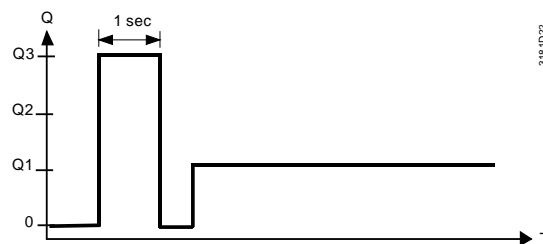

Fan overrun for electric heater

When the electric heater is switched off, the fan overruns for 60 seconds (parameter P54) to avoid overtemperature of the electric heater or prevent the thermal cutout from responding.

⚠ Fan failure

In case of fan failure, the thermostat cannot protect the electric heater against overtemperature. For this reason, the electric heater must feature a separate safety device (thermal cutout).

Clean fan filter reminder

The "Clean fan filter reminder" function counts the fan operating hours and displays message "FIL 🔔" to remind the user to change/clean the fan filter as soon as the threshold is reached. This does not impact the thermostat's operation, which continues to run normally. The function is set via parameter P62 (default = Off (0)).
The "Clean filter reminder" is reset when the operating mode is manually set to Protection and back.

Fan in Auto Timer mode (RDG1..T)

In Auto Timer mode , the default fan mode is automatic. The fan mode can be changed to Manual by pressing the FAN button. The fan returns to the automatic default mode after each switchover from Comfort to Economy mode, and vice versa.

Fan start delay

To let the heating/cooling coil reach its temperature, the fan start can be delayed by a time period set via parameter P67.

Function available with:

RDG100...: On/Off control outputs

RDG110...: On/Off control outputs

RDG160T...: On/Off and DC control outputs, 3-speed and DC fan

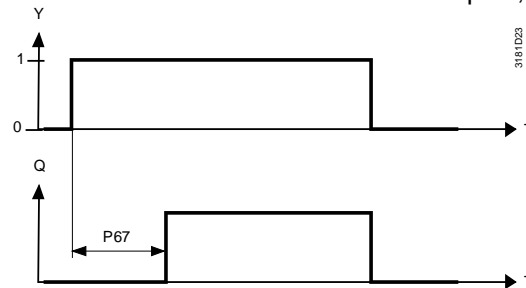

4.10 Multifunctional input, digital input

The thermostat has 2 multifunctional inputs X1 and X2 and a digital input D1. A sensor type NTC like the QAH11.1 (AI, analog input) or a switch (DI, digital input) can be connected to the input terminals. The functionality of the inputs can be configured via parameters P38 for X1, P40 for X2, and P42 for D1.

#	Function of input	Description	Type X1/X2	Type DI
0	Not used	No function.	--	--
1	External/return air temperature	Sensor input for external room temperature sensor or return air temperature sensor to acquire the current room temperature, or floor heating temperature sensor to limit the heating output. <i>Note:</i> The room temperature is acquired by the built-in sensor if the floor temperature limitation function is enabled via parameter P51.	AI	
2	Heating/cooling changeover	Sensor input for automatic heating/cooling changeover function. A switch can also be connected rather than a sensor Important: Switch closed means always cooling, (this cannot be changed), see section 4.6.	AI/(DI)	DI
3	Operating mode switchover	Digital input to switch over the operating mode to Economy. If the operating mode switchover contact is active, user operations are ineffective and "OFF" is displayed.	DI	DI
4	Dewpoint monitor	Digital input for a dewpoint sensor to detect condensation. Cooling is stopped if condensation occurs.	DI	DI
5	Enable electric heater	Digital input to enable/disable the electric heater via remote control.	DI	DI
6	Fault	Digital input to signal an external fault (example: dirty air filter). If the input is active, "ALx" is displayed (Alarm x, with x = 1 for X1, x = 2 for X2, x = 3 for D1). <i>Note:</i> Fault displays do not influence the thermostat's operation. They merely represent a visual signal.	DI	DI
9	Supply air temperature limitation (RDG160T.. only)	Sensor input to acquire the supply air temperature. The thermostat controls the room temperature via the built-in sensor. The control output (DC 0...10 V) is reduced if the supply air temperature exceeds the min/max limits (P63, P64).	AI	--

Operational action can be changed between normally open (NO) and normally closed (NC) via parameter P39, P41 (or P43 if it is a digital input).

Each input X1, X2 or D1 must be configured with a different function (1...5, 9).
Exception: 1, 2 or 3 inputs can be configured as alarm inputs (6).

X1 is factory-set to "External sensor" (1), X2 to "Heating/cooling changeover" (2), and D1 to "Operating mode changeover" (3).

If a multifunctional input is configured as analog: "Err" will be displayed when the output is out of range (0...49 °C (32...120 °F)), open or shorted.
For more details, refer to section 4.5.

Installation notes

- For inputs X1, X2, or D1, one physical switch can be used for up to 20 thermostats (parallel connection).
Caution! DO NOT mix X1/X2 (mains potential) and D1.
- For sensors on inputs X1, X2, or D1, the cable length is max. 80 m.

4.11 Auto timer (RDG100T, RDG100T/H, RDG160T.. only)

The thermostat provides an Auto Timer mode with 8 programmable timers. Each timer can be assigned to one or several days. In this mode, the thermostat automatically changes over between Comfort and Economy mode according to the preprogrammed timers.

Buttons of the RDG100T/H

Button ✓ = bottom, button  = top (see operating instructions B3181.4).

Setting the time of day and the weekday

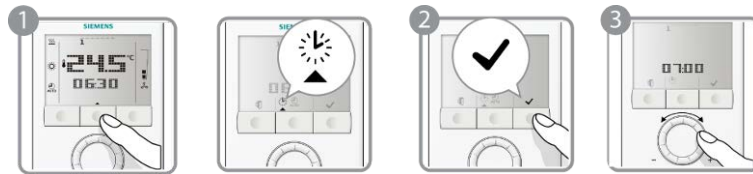



1. Press the program mode button to enter the programming mode menu.
2. Press button ✓ (OK) to enter the setting mode for the time of day. The time digits start blinking.
3. Turn the rotary knob clock- or counterclockwise to set the time of day.

12-hour and 24-hour format

If the current time of day is in 24-hour format and you wish to change it to 12-hour format, turn the knob clockwise passed 23:59 or counterclockwise passed 00:00.

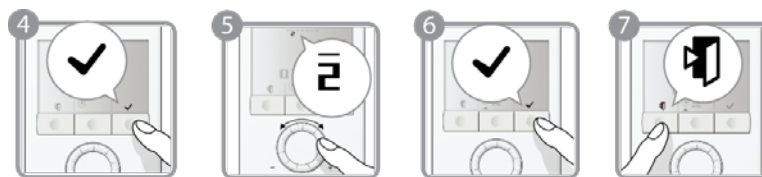
If the current time of day is in 12-hour format and you wish to change it to 24-hour format, turn the knob clockwise passed 12:00 pm or counterclockwise passed 12:00 am.



4. Confirm the time of day by pressing the right button ✓
The weekday indicator starts blinking.
5. Turn the rotary knob clock- or counterclockwise to set the current weekday.
6. Confirm the current weekday by pressing button ✓ (OK).
7. Press the program mode button  (Esc) to leave the program mode.

- Note
- RDG100T...: Time and weekday are always visible on the display, even when auto timer is OFF (P02 = 3 or 4).
 - RDG160T...: Time and weekday are NOT visible on the display when auto timer is disabled, either by setting P02 to 3, 4 or DIP5 to ON.





Power failure

After a power failure, the time of day will blink to indicate power was lost. However the auto timer will continue to run with the time before the power loss occurred. Enter the setting mode to adjust the time of day if needed.

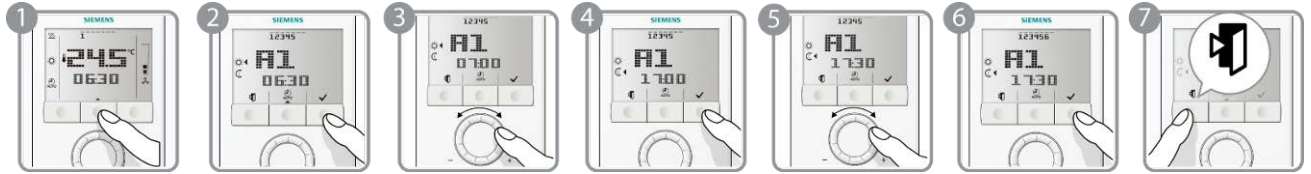
Setting the timers (RDG1x0T.. only)

The RDG100T, RDG100T/H, and RDG160T.. provide 8 programmable timers A1...A8. Each timer has a Comfort mode start and end time that can be applied to one or several weekdays. To set an auto timer, proceed as follows:



1. Press the program mode button twice to select "Auto timer setting"  on the "Programming mode" menu.
2. Turn the rotary knob to the desired timer A1...A8 that you wish to adjust and press button ✓ (OK).
3. Turn the rotary knob to adjust the Comfort mode start time and confirm by pressing button ✓ (OK).
4. Turn the rotary knob to adjust the Comfort mode end time or Economy start time respectively and confirm by pressing button ✓ (OK).
5. Weekday **1**, ✓ and  blink. Press button ✓ (OK) to select or button  (Esc) to deselect each day and advance to the next day.
6. After the 7th day is adjusted, all selected weekdays blink. Confirm setting for actual timer by pressing button ✓ (OK) and advance to the next timer. To adjust the next timer, repeat step 3...6 or press button  (Esc) to leave the setting mode.



Notes

- To save your adjustments, remember to press button ✓ (OK) in step 6 above before pressing button  (Esc) to leave the programmable timer setting mode.
- Auto timer can be disabled via parameter P02 (=3 or 4), (RDG1..T..) or via DIP5 = ON on RDG160T...
- RDG100T...: Time and weekday are always visible on the display, even when auto timer is OFF (P02 = 3 or 4).
- RDG160T...: Time and weekday are NOT visible on the display when auto timer is disabled, either by setting P02 to 3, 4 or DIP5 to ON.

View the programmable settings

You can view the 8 timers in sequence:



1. Press the program mode button twice to select the "Auto timer setting"  in programming mode.
2. Turn the rotary knob to review the 8 auto timers.
3. Press button  (Esc) to return to normal operation.



Default timer settings

Timers A1...A4 have the following default settings (residential use):

Days	Time when thermostat is in Comfort mode	
Mon(1)- Fri(5)	06:30 – 08:30 (A1)	17:30 – 22:30 (A2)
Sat (6)	08:00-23:00 (A3)	
Sun (7)	08:00-22:30(A4)	
	<ul style="list-style-type: none"> The thermostat is in Economy mode ☺ during the remaining time Timers A5...A8 are free with no default settings 	

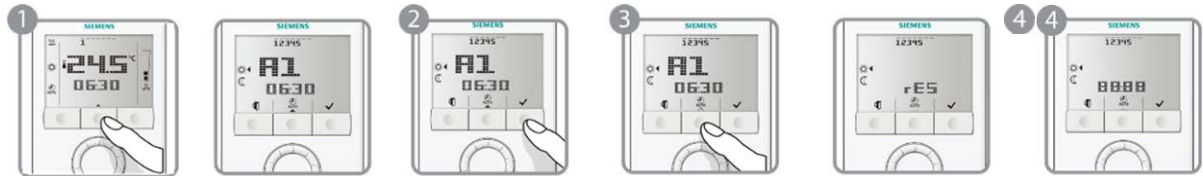
Reloading the default timer settings



1. Press the program mode button twice to select the "Auto timer setting"  in programming mode.
2. Press button ✓ (OK) to enter the timer setting mode.
3. Press the program mode button for at least 3 seconds. "rES" will be displayed.
4. Press button ✓ (OK) to confirm reloading of the default timer settings or button  (Esc) to leave without change. The display shows "8888" during the reloading process.

Overlapping of timer sequences

When several timer sequences overlap, the resulting output is the OR combination of the Comfort mode time of all timers.

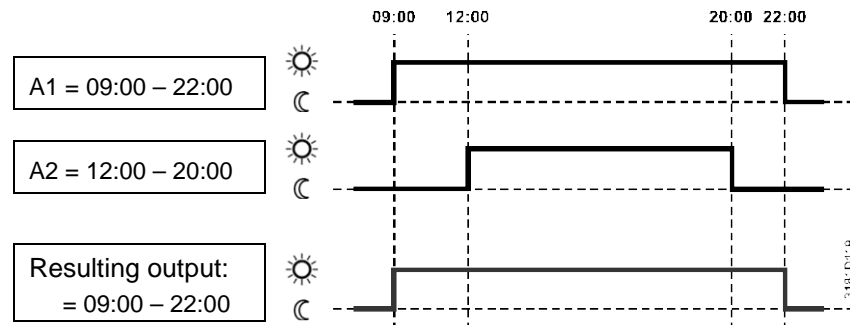

4.12 Handling faults

Temperature out of range

When the room temperature is outside the measuring range, i.e. above 49 °C (120 °F) or below 0 °C (32 °F), the limiting temperatures blink, e.g. "0 °C (32 °F)" or "49 °C (120 °F)".

In addition, the heating output is activated if the current setpoint is not set to "OFF", the thermostat is in heating mode and the temperature is below 0 °C (32 °F).

For all other cases, no output is activated.

The thermostat resumes Comfort mode after the temperature returns to within the measuring range.

Fault "Er1" on display

When the built-in sensor fails and no external sensor is connected, the thermostat shows the fault message "Er1" on the display. The thermostat needs to be replaced if the room temperature needs to be measured with the built-in sensor.

4.13 Infrared remote control

Use the IRA211 infrared remote control to operate a thermostat with built-in infrared receiver. The following operations can be carried out remotely:

- Select Protection, Comfort or Auto Timer mode
- Adjust setpoint in Comfort mode
- Select fan mode "Automatic" or "Manual"

A buzzer in the thermostat indicates remote control command reception.

Infrared remote control can be disabled via parameter P70.

4.14 DIP switches



Use the DIP switches at the rear of the thermostat to commission the thermostat's basic application prior to snapping it to the base.

- The application is set via DIP switches 1...3
- The function of the control outputs (2-position or 3-position) is set via DIP switches 4 and 5 for RDG 100, RDG100T and RDG100T/H.
- For RDG160T.. (DC 0...10 V), DIP switches 4 select either DC fan (DIP4=OFF) or 3-speed fan (DIP4=ON). DIP5 set to ON disables the time program functions and the time is not visible anymore on the display.

For details concerning connection of peripheral devices and setting of the DIP switches, refer to the Mounting Instructions:

- [4] M3181.1 (RDG100, RDG100T)
- [5] M3181.2 (RDG110)
- [6] M3181.5 (RDG160T)
- [7] M3181.4 (RDG100T/H)
- [9] M3183.1 (RDG110U)
- [10] M3183.2 (RDG160TU)

Note During startup, the thermostat reloads the control parameter factory settings after each change of DIP switch setting.

4.15 Control parameters

A number of control parameters can be readjusted to optimize control performance. These parameters can also be set during operation without opening the unit. In the event of a power failure, all control parameter settings are retained.

The control parameters are assigned to 2 levels:

- "Service level", and
- "Expert level" with "Diagnostics and test"

The "Service level" contains a small set of parameters to set up the thermostat for the HVAC system and to adjust the user interface. These parameters can usually be adjusted any time.

Change parameters at the "Expert level" carefully, as they impact control performance and functionality of the thermostat.

Parameter setting

Change the parameters as follows:

Enter only "Service level"

1. Press left and right button simultaneously for 4 seconds. Release and press the right button again within 2 seconds until the display shows "P01". Continue with step 2.

Enter "Expert level" and "Diagnostics and test"

1. Press left button and right button simultaneously for 4 seconds. Release and press the left button again within 2 seconds until the temperature disappears. Turn the rotary knob counterclockwise min. ½ rotation. The display shows "Pxx". Continue with step 2.

Adjusting parameters

2. Select the required parameter by turning the rotary knob.
3. Press button ✓ (OK); the current value of the selected parameter starts blinking and can be changed by turning the rotary knob.
4. Press button ✓ (OK) to confirm the adjusted value or press button ↵ (Esc) to cancel the change.
5. If you wish to adjust additional parameters, repeat steps 2...4.
6. Press button ↵ (Esc) to leave the parameter setting mode.

Resetting parameters

The factory setting for the control parameters can be reloaded via parameter P71, by changing the value to "ON". Confirm by pressing the right button. The display shows "8888" during reloading.

Buttons of the RDG100T/H

Button ✓ = bottom, button ↵ = top (see operating instructions B3181.4).

4.15.1 Parameters of the "Service level" – Degree Celsius

Parameter	Name	Factory setting	Range	RDG100	RDG100T	RDG100T/H	RDG110 RDG110U	RDG160T RDG160TU	Dependencies
	Service level								
P01	Control sequence	With 2-pipe/ 2-stage: 1 = cooling only With 4-pipe: 4 = H/C	0 = heating only 1 = cooling only 2 = H/C changeover manually 3 = H/C changeover automatically 4 = heating and cooling	✓	✓	✓	✓	✓	
P02	Operating mode profile (operating mode button)	1	1 = (Auto) - Comfort – Protection 2 = (Auto) - Comfort - Economy - Prot 3 = Comfort – Protection 4 = Comfort – Economy – Protection	✓ x	✓	✓	✓ x	✓	P01
P03	Fan mode selection	0	0 = Auto – Manual 1 = Manual 2 = Auto – Manual – Prot 3 = Auto – Prot	✓ x	✓ x	✓ x	✓ x	✓	P52
P04	Selection of °C or °F	0 (°C)	0 = degrees Celsius (°C) 1 = degrees Fahrenheit (°F)	✓	✓	✓	✓	✓	
P05	Sensor calibration (internally, externally)	0 K	– 3...3 K	✓	✓	✓	✓	✓	
P06	Standard temperature display	0	0 = room temperature 1 = setpoint	✓	✓	✓	✓	✓	
P07	Display info line (2nd line of LCD)	0	0 = --- (no display) 1 = °C and °F	0..1	x	x	0..1	x	
P08	Comfort setpoint	21 °C	5...40 °C	✓	✓	✓	✓	✓	
P09	Min. setpoint for Comfort mode	5 °C	5...40 °C	✓	✓	✓	✓	✓	
P10	Max. setpoint for Comfort mode	35 °C	5...40 °C	✓	✓	✓	✓	✓	
P11	Economy heating setpoint	15 °C	OFF, 5...WcoolE-saving; (WcoolE-saving = 40 °C max.)	✓	✓	✓	✓	✓	
P12	Economy cooling setpoint	30 °C	OFF, WHeatEco...40 °C; (WHeatEco = 5 °C min.)	✓	✓	✓	✓	✓	
P13	Electric heater in cooling mode	ON	ON: Enabled OFF: Disabled	✓	✓	✓	✓	✓	Appl
P14	Button lock function	0	0 = unlocked 1 = auto locked 2 = manual locked	✓	✓	✓	✓	✓	
P15	Fan stage in dead zone (Comfort)	0	0 = disabled 1 = stage 1 (heating and cooling) 2 = stage 1 (cooling only)	✓	✓	✓	✓	✓	

- ✓ Parameter available
- ✗ Parameter not available

Note Parameter display depends on selected application and function.

4.15.2 Parameters of the "Expert level with diagnostics and test" – Degree Celsius

Parameter	Name	Factory setting	Range	RDG100	RDG100T	RDG100T/H	RDG110 RDG110U	RDG160T RDG160TU	Dependencies
	Expert level								
P30	P-band/switching differential in heating mode	2 K	0.5...6 K	✓	✓	✓	✓	✓	
P31	P-band/switching differential in cooling mode	1 K	0.5...6 K	✓	✓	✓	✓	✓	
P32	P-band/switching differential for radiator	2 K	0.5...6 K	✓	✓	✓	✓	✓	Appl
P33	Dead zone in Comfort mode	2 K	0.5...5 K	✓	✓	✓	✓	✓	Appl
P34	Setpoint differential (w _D)	2 K	0.5...5 K	✓	✓	✓	✓	✓	Appl
P35	Integral action time	RDG100.. 5 min.	0...10 min.	✓	✓	✓	x	x	P46, P47
		RDG160T/160TU 45 min.	0...120 min.	x	x	x	x	✓	
P36	Heating/cooling changeover switching point cooling (X1/X2)	16 °C	10...25 °C	✓	✓	✓	✓	✓	P38, P40
P37	Heating/cooling changeover switching point heating (X1/X2)	28 °C	27...40 °C	✓	✓	✓	✓	✓	P38, P40
P38	Functionality of X1	1 = external sensor	0 = --- (no function) 1 = room temp ext/ret air temp (AI) 2 = H/C changeover (AI/DI) 3 = operating mode contact (DI) 4 = dewpoint sensor (DI) 5 = enable electric heater (DI) 6 = fault input (DI) 9 = Supply air sensor	✓ 0.6	✓ 0.6	✓ 0.6	✓ 0.6	✓ 0.9	
P39	Operating action of X1 if digital input	NO	NO = normally open/open NC = normally closed/closed	✓	✓	✓	✓	✓	P38
P40	Functionality of X2	2 = H/C changeover	0 = --- (no function) 1 = room temp ext/ret air temp (AI) 2 = H/C changeover (AI/DI) 3 = operating mode contact (DI) 4 = dewpoint sensor. (DI) 5 = enable electric heater (DI) 6 = fault input (DI) 9 = Supply air sensor	✓ 0.6	✓ 0.6	✓ 0.6	✓ 0.6	✓ 0.9	
P41	Operating action of X2 if digital input	NO	NO = normally open/open NC = normally closed/closed	✓	✓	✓	✓	✓	P40
P42	Functionality of D1	3 = operating mode changeover	0 = --- (no function) 2 = H/C changeover (DI) 3 = operating mode contact (DI) 4 = dewpoint sensor (DI) 5 = enable electric heater (DI) 6 = fault input (DI)	✓ 0.6	✓ 0.6	✓ 0.6	✓ 0.6	✓ 0.6	
P43	Operating action of D1 if digital input	NO	NO = normally open/open NC = normally closed/closed	✓	✓	✓	✓	✓	P42
P44	Running time of Y1/Y2 output (only with modulating PI control)	150 s	20...300 s	✓	✓	✓	x	x	P46
P45	Running time of Y3/Y4 output (only with modulating PI control)	150 s	20...300 s	✓	✓	✓	x	x	P47
P45	Power of electric heater on Q2 (for adaptive temperature compensation)	0 kW	0.0...1.2 kW	x	x	x	x	✓	
P46	Output Y1/Y2 (if not parameterized as 3-pos.)	On/Off (1)	1 = On/Off 2 = PWM	✓	✓	✓	x	x	Appl
P46	Outputs Y10 (DC) or Q1 (2-pos)	DC 0...10 V (2)	1 = On/Off 2 = DC 0...10V	x	x	x	x	✓	Appl
P46	Load current of electric heater on Y21 (for adaptive temperature compensation, not available for RDG110U)	1 A	1...5 A	x	x	x	✓	x	Appl
P47	Output Y3/Y4 (if not parameterized as 3-pos.)	On/Off (1)	1 = On/Off 2 = PWM	✓	✓	✓	x	x	Appl
P47	Outputs Y20 (DC) or Q2 (2.pos)	DC 0...10 V (2)	1 = On/Off 2 = DC 0...10V	x	x	x	x	✓	Appl
P48	Min. output on time 2-position control output	1 min.	1...20 min.	✓	✓	✓	✓	✓	P46
P48	Min. output ON time on Q1, Q2 and Q3, Relay function P72, P73, P74 (=2,3,4,5):	1 min.	1...20 min.	x	x	x	x	✓	Appl P7x
P49	Min. output off time 2-position control output	1 min.	1...20 min.	✓	✓	✓	✓	✓	P47
P49	Min. output OFF time on Q1, Q2 and Q3 Relay function P72, P73, P74 (=2,3,4,5):	1 min.	1...20 min.	x	x	x	x	✓	Appl P7x
P50	Purging function (only when changeover with local sensor is selected)	OFF	OFF: Not active 1...5 min: Active with selected duration	✓	✓	✓	✓	✓	P38, P40
P51	Floor heating limit temperature	OFF	OFF, 10...50 °C	✓	✓	✓	✓	✓	P38, P40

- ✓ Parameter available
- ✗ Parameter not available

Notes

- P46, P47: Setting to 2-position or 3-position is made with DIP switches 4 and 5.
- P45 (RDG160T..) and P46 (RDG110) to compensate for heat dissipation of the electric heater relay.
- If no sensors or switches are connected, it is not necessary to disable the inputs (P38, P40 or P42 = no function), the thermostat recognizes if a sensor is connected (but diagnostic shows "Err").

Parameter	Name	Factory setting	Range	RDG100	RDG100T	RDG100T/H	RDG110 RDG110U	RDG160T RDG160TU	Dependencies
	Expert level								
P52	Fan operation	1	0 = disabled 1 = enabled 2 = heating only 3 = cooling only	✓	✓	✓	✓	✓	
P53	Fan speed	3-speed	1 = 1-speed 2 = 3-speed	✓	✓	✓	✓	x	P52
P53	Fan speed	DC 0...10 V	1 = 1-speed fan 2 = 3-speed fan 3 = DC 0...10 V (ECM fan)	x	x	x	x	✓	P52 DIP4
P54	Fan overrun time (only when electric heater is used)	60 s	0...360 s	✓	✓	✓	✓	✓	P52, Appl
P55	Switching point fan speed high	100%	80..100%	✓	✓	✓	✓	✓	P52
	ECM fan max. output	ECM: 80%	ECM: fan min...100%	x	x	x	x	✓	P52
P56	Switching point fan speed medium	65%	30...75%	✓	✓	✓	✓	✓	P52
	ECM fan min. output	ECM: 30%	ECM: 1%...fan max.	x	x	x	x	✓	P52
P57	Switching point fan speed low	10%	1...15%	✓	✓	✓	✓	✓	P52
	ECM: Switching point fan	ECM:10%	ECM: 1..100%	x	x	x	x	✓	P52
P58	Fan start booster	ON	ON: Enabled OFF: Disabled	✓	✓	✓	✓	✓	P52
P59	Fan min. on time	2 min.	1...6 min	✓	✓	✓	✓	✓	P52
P60	Fan kick interval in Comfort mode (time until next kick)	OFF	0...89 min, OFF	✓	✓	✓	✓	✓	P52
P61	Fan kick interval in Economy mode (time until next kick)	OFF	0...359 min, OFF	✓	✓	✓	✓	✓	P52
P62	Clean filter reminder running time	OFF (0)	OFF, 100...9900 hours	✓	✓	✓	✓	✓	P52
P63	Minimum supply air temperature	OFF	OFF, 0...P64 °C	x	x	x	x	✓	P38, P40
P64	Maximum supply air temperature	OFF	OFF, 0...P64 °C	x	x	x	x	✓	P38, P40
P65	Protection heating setpoint	8 °C	OFF, 5...W Cool Prot; (W Cool Prot = 40 °C max.)	✓	✓	✓	✓	✓	
P66	Protection cooling setpoint	OFF	OFF, W Heat Prot...40; (W Heat Prot = 5 °C min.)	✓	✓	✓	✓	✓	
P67	Fan start delay	RDG100../110/110U RDG160T/160TU	0 s 0...180 s 0...360 s	✓	✓	✓	✓	✓	P52, P46, P47
P68	Extension Comfort period	OFF (0)	OFF(0); 15...360 min	✓	✓	✓	✓	✓	P02
P69	Temporary setpoint Comfort mode (see also Comfort setpoint P08)	OFF	OFF = disabled ON = enabled	✓	✓	✓	✓	✓	
P70	Infrared receiver	ON	OFF = disabled ON = enabled	x	✓	✓	x	✓	
P71	Reload factory settings	OFF	OFF = disabled ON = reload start	✓	✓	✓	✓	✓	
P72	Output Q1 function	0	0 = No function 1= Switch OFF in Protection 2= Switch ON in H/C demand (2-pipe) 3= Switch ON in H demand (4-pipe) 4= Switch ON in C demand (4-pipe) 5= Status active sequence (H or C)	x	x	x	x	✓	App
P73	Output Q2 function	0	0 = No function 1= Switch OFF in Protection 2= Switch ON in H/C demand (2-pipe) 3= Switch ON in H demand (4-pipe) 4= Switch ON in C demand (4-pipe) 5= Status active sequence (H or C)	x	x	x	x	✓	App
P74	Output Q3 function	0	0 = No function 1= Switch OFF in Protection 2= Switch ON in H/C demand (2-pipe) 3= Switch ON in H demand (4-pipe) 4= Switch ON in C demand (4-pipe) 5= Status active sequence (H or C)	x	x	x	x	✓	App

- ✓ Parameter available
- ✗ Parameter not available

4.15.3 Parameters of the "Service level" – Degree Fahrenheit

Parameter	Name	Factory setting	Range	RDG110U	RDG160TU	Dependencies
	Service level					
P01	Control sequence	With 2-pipe/ 2-stage: 1 = cooling only With 4-pipe: 4 = H/C	0 = heating only 1 = cooling only 2 = H/C changeover manually 3 = H/C changeover automatically 4 = heating and cooling	✓	✓	
P02	Operating mode profile (operating mode button)	1	1 = (Auto) - Comfort – Protection 2 = (Auto) - Comfort - Economy - Prot 3 = Comfort – Protection 4 = Comfort – Economy – Protection	✓ x	✓	P01
P03	Fan mode selection	0	0 = Auto – Manual 1 = Manual 2 = Auto – Manual – Prot 3 = Auto – Prot	✓ x	✓	P52
P04	Selection of °C or °F	Depends on Wizard setting	0 = degrees Celsius (°C) 1 = degrees Fahrenheit (°F)	✓	✓	
P05	Sensor calibration (internally, externally)	0 °F	–6...6 °F	✓	✓	
P06	Standard temperature display	0	0 = room temperature 1 = setpoint	✓	✓	
P07	Display info line (2nd line of LCD)	0	0 = --- (no display) 1 = °C and °F	0..1	x	
P08	Comfort setpoint	70 °F	41...104 °F	✓	✓	
P09	Min. setpoint for Comfort mode	41 °F	41...104 °F	✓	✓	
P10	Max. setpoint for Comfort mode	95 °F	41...104 °F	✓	✓	
P11	Economy heating setpoint	59 °F	OFF, 41...WcoolE-saving; (WcoolE-saving = 104 °F max.)	✓	✓	
P12	Economy cooling setpoint	86 °F	OFF, WHeatEco...104 °F; (WHeatEco = 41 °F min.)	✓	✓	
P13	Electric heater in cooling mode	ON	ON: Enabled OFF: Disabled	✓	✓	Appl
P14	Button lock function	0	0 = unlocked 1 = auto locked 2 = manual locked	✓	✓	
P15	Fan stage in dead zone (Comfort)	0	0 = disabled 1 = stage 1 (heating and cooling) 2 = stage 1 (cooling only)	✓	✓	

✓ Parameter available

x Parameter not available

Note Parameter display depends on selected application and function.

4.15.4 Parameters of the "Expert level with diagnostics and test" – Degree Fahrenheit

Parameter	Name	Factory setting	Range	RDG110U	RDG160TU	Dependencies
	Expert level					
P30	P-band/switching differential in heating mode	4 °F	1...12 °F	✓	✓	
P31	P-band/switching differential in cooling mode	2 °F	1...12 °F	✓	✓	
P32	P-band/switching differential for radiator	4 °F	1...12 °F	✓	✓	Appl
P33	Dead zone in Comfort mode	4 °F	1...10 °F	✓	✓	Appl
P34	Setpoint differential (w _b)	4 °F	1...10 °F	✓	✓	Appl
P35	Integral action time RDG160TU	45 min.	0...120 min.	x	✓	P46, P47
P36	Heating/cooling changeover switching point cooling (X1/X2)	61 °F	50...77 °F	✓	✓	P38, P40
P37	Heating/cooling changeover switching point heating (X1/X2)	82 °F	81...104 °F	✓	✓	P38, P40
P38	Functionality of X1	1 = external sensor	0 = --- (no function) 1 = room temp ext/ret air temp (AI) 2 = H/C changeover (AI/DI) 3 = operating mode contact [DI] 4 = dewpoint sensor (DI) 5 = enable electric heater (DI) 6 = fault input (DI) 9 = Supply air sensor	✓ 0..6	✓ 0..9	
P39	Operating action of X1 if digital input	NO	NO = normally open/open NC = normally closed/closed	✓	✓	P38
P40	Functionality of X2	2 = H/C changeover	0 = --- (no function) 1 = room temp ext/ret air temp (AI) 2 = H/C changeover (AI/DI) 3 = operating mode contact [DI] 4 = dewpoint sensor. (DI) 5 = enable electric heater (DI) 6 = fault input (DI) 9 = Supply air sensor	✓ 0..6	✓ 0..9	
P41	Operating action of X2 if digital input	NO	NO = normally open/open NC = normally closed/closed	✓	✓	P40
P42	Functionality of D1	3 = operating mode changeover	0 = --- (no function) 2 = H/C changeover (DI) 3 = operating mode contact [DI] 4 = dewpoint sensor (DI) 5 = enable electric heater (DI) 6 = fault input (DI)	✓ 0..6	✓ 0..6	
P43	Operating action of D1 if digital input	NO	NO = normally open/open NC = normally closed/closed	✓	✓	P42
P45	Power of electric heater on Q2 (for adaptive temperature compensation)	0 kW	0.0...1.2 kW	x	✓	
P46	Outputs Y10 (DC) or Q1 (2-pos)	DC 0...10 V (2)	1 = On/Off 2 = DC 0...10V	x	✓	Appl
P47	Outputs Y20 (DC) or Q2 (2.pos)	DC 0...10 V (2)	1 = On/Off 2 = DC 0...10V	x	✓	Appl
P48	Min. output on time 2-position control output	1 min.	1...20 min.	✓	✓	P46
P48	Min. output ON time on Q1, Q2 and Q3, Relay function P72, P73, P74 (=2,3,4,5):	1 min.	1...20 min.	x	✓	Appl P7x
P49	Min. output off time 2-position control output	1 min.	1...20 min.	✓	✓	P47
P49	Min. output OFF time on Q1, Q2 and Q3 Relay function P72, P73, P74 (=2,3,4,5):	1 min.	1...20 min.	x	✓	Appl P7x
P50	Purging function (only when changeover with local sensor is selected)	OFF	OFF: Not active 1...5 min: Active with selected duration	✓	✓	P38, P40
P51	Floor heating limit temperature	OFF	OFF, 50...122 °F	✓	✓	P38, P40







- ✓ Parameter available
- ✗ Parameter not available

- P46, P47: Setting to 2-position or 3-position is made with DIP switches 4 and 5.
- P45 (RDG160TU) to compensate for heat dissipation of the electric heater relay.
- If no sensors or switches are connected, it is not necessary to disable the inputs (P38, P40 or P42 = no function), the thermostat recognizes if a sensor is connected (but diagnostic shows "Err").

Parameter	Name	Factory setting	Range	RDG110U	RDG160TU	Dependencies
	Expert level					
P52	Fan operation	1	0 = disabled 1 = enabled 2 = heating only 3 = cooling only	✓	✓	
P53	Fan speed	3-speed	1 = 1-speed 2 = 3-speed	✓	x	P52
P53	Fan speed	DC 0...10 V	1 = 1-speed fan 2 = 3-speed fan 3 = DC 0...10 V (ECM fan)	x	✓	P52 DIP4
P54	Fan overrun time (only when electric heater is used)	60 s	0...360 s	✓	✓	P52, Appl
P55	Switching point fan speed high	100%	80...100%	✓	✓	P52
	ECM fan max. output	ECM: 80%	ECM: fan min...100%	x	✓	P52
P56	Switching point fan speed medium	65%	30...75%	✓	✓	P52
	ECM fan min. output	ECM: 30%	ECM: 1%...fan max.	x	✓	P52
P57	Switching point fan speed low	10%	1...15%	✓	✓	P52
	ECM: Switching point fan	ECM:10%	ECM: 1..100%	x	✓	P52
P58	Fan start booster	ON	ON: Enabled OFF: Disabled	✓	✓	P52
P59	Fan min. on time	2 min.	1...6 min	✓	✓	P52
P60	Fan kick interval in Comfort mode (time until next kick)	OFF	0...89 min, OFF	✓	✓	P52
P61	Fan kick interval in Economy mode (time until next kick)	OFF	0...359 min, OFF	✓	✓	P52
P62	Clean filter reminder running time	OFF (0)	OFF, 100...9900 hours	✓	✓	P52
P63	Minimum supply air temperature	OFF	OFF, 32...P64 °F	x	✓	P38, P40
P64	Maximum supply air temperature	OFF	OFF, P63...122 °F	x	✓	P38, P40
P65	Protection heating setpoint	8 °C	OFF, 41...W Cool Prot; (W Cool Prot = 104 °F max.)	✓	✓	
P66	Protection cooling setpoint	OFF	OFF, W Heat Prot...104 °F ; (W Heat Prot = 41 °F min.)	✓	✓	
P67	Fan start delay	RDG110U RDG160TU 0 s	0...180 s 0...360 s	✓	✓	P52, P46, P47
P68	Extension Comfort period	OFF (0)	OFF(0); 15...360 min	✓	✓	P02
P69	Temporary setpoint Comfort mode (see also Comfort setpoint P08)	OFF	OFF = disabled ON = enabled	✓	✓	
P70	Infrared receiver	ON	OFF = disabled ON = enabled	x	✓	
P71	Reload factory settings	OFF	OFF = disabled ON = reload start	✓	✓	
P72	Output Q1 function	0	0 = No function 1 = Switch OFF in Protection 2 = Switch ON in H/C demand (2-pipe) 3 = Switch ON in H demand (4-pipe) 4 = Switch ON in C demand (4-pipe) 5 = Status active sequence (H or C)	x	✓	App
P73	Output Q2 function	0	0 = No function 1 = Switch OFF in Protection 2 = Switch ON in H/C demand (2-pipe) 3 = Switch ON in H demand (4-pipe) 4 = Switch ON in C demand (4-pipe) 5 = Status active sequence (H or C)	x	✓	App
P74	Output Q3 function	0	0 = No function 1 = Switch OFF in Protection 2 = Switch ON in H/C demand (2-pipe) 3 = Switch ON in H demand (4-pipe) 4 = Switch ON in C demand (4-pipe) 5 = Status active sequence (H or C)	x	✓	App

- ✓ Parameter available
- x Parameter not available

4.15.5 Diagnostics and tests

Parameter	Name	Factory setting	Range	RDG100	RDG100T	RDG100T/H	RDG110 RDG110U	RDG160T RDG160TU	Dependencies
	Diagnostics and test								
d01	Application type	Diagnostics	0 = (no application) 1 = 2-pipe 2 = 2-pipe with electric heater 3 = 2-pipe with radiator 4 = 4-pipe 5 = 2 stage heating or cooling 6 = 4-pipe with electric heater	✓	✓	✓	✓	✓	
d02	X1 status	Diagnostics	"---" = function not selected 0 = not activated (for DI) 1 = Activated (DI) 0...49 °C = Curr. temp. value (for AI) Err 00  = H/C input closed 100  = H/C input open	✓	✓	✓	✓	✓	
d03	X2 status	Diagnostics	"---" = function not selected 0 = not activated (for DI) 1 = Activated (DI) 0...49 °C = Curr. temp. value (for AI) Err 00  = H/C input closed 100  = H/C input open	✓	✓	✓	✓	✓	
d04	D1 status	Diagnostics	"---" = function not selected 0 = not activated (for DI) 1 = Activated (DI) 00  = H/C input closed 100  = H/C input open	✓	✓	✓	✓	✓	
d05	Test mode for checking actuator direction Y1/Y2 (press left button to escape)	---	"---" = no signal at outputs Y1 and Y2 OPE = output Y1 forced opening CLO = output Y2 forced closing	✓	✓	✓	x	x	P46
d06	Test mode for checking actuator direction Y3/Y4 (press left button to escape)	---	"---" = no signal at outputs Y3 and Y4 OPE = output Y3 forced opening CLO = output Y4 forced closing	✓	✓	✓	x	x	P47
d07	Software version	---	Ux.xx is displayed	✓	✓	✓	✓	✓	
d08	Test mode for checking Q1 output	---	"---" = no signal at output Q1 OPE = output Q1 forced opening CLO = output Q1 forced closing	x	x	x	x	✓	P72, App
d09	Test mode for checking Q2 output	---	"---" = no signal at output Q2 OPE = output Q2 forced opening CLO = output Q2 forced closing	x	x	x	x	✓	P73, App
d10	Test mode for checking Q3 output	---	"---" = no signal at output Q3 OPE = output Q3 forced opening CLO = output Q3 forced closing	x	x	x	x	✓	P74, App

✓ Parameter available

✗ Parameter not available

) If input is parameterized as analog (P38 or P40 = 1) or set to "0": "Err" on the diagnostic parameter is displayed when input is out of range (0...49 °C), open or shorted (on RDG100.. and RDG110..).

5 Handling

5.1 Mounting and installation

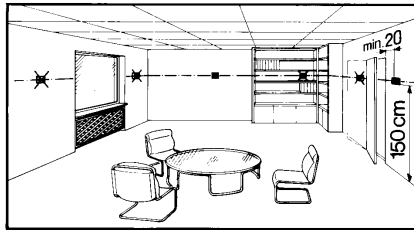

Do not mount on a wall in niches or bookshelves, behind curtains, above or near heat sources, or exposed to direct solar radiation. Mount about 1.5 m (5 feet) above the floor.

Mounting



- The room thermostat must be mounted in a clean, dry indoor place and must not be exposed to drip or splash water.

Wiring



See Mounting Instructions (M3181.. or M3183..) enclosed with the thermostat.

- Comply with local regulations to wire, protection and earth the thermostat.



Warning!

No internal line protection for supply lines to external consumers (Q1, Q2, Q3, Yx or Yxx)

Risk of fire and injury due to short-circuits!

- Adapt the line diameters as per local regulations to the rated value of the installed overcurrent protection device.
- The AC 230 V mains or AC 24 V supply line must have a circuit breaker with a rated current of no more than 10 A. For AC 24 V US installations, use Class 2 rated power supplies.
- Properly size the cables to the thermostat, fan and valve actuators for AC 230 V mains voltage.
- Use only valve actuators rated for AC 230 V on RDG100.., RDG110 and on RDG160T if AC 230 V is connected to the "L" terminal.
- Use only 3-speed fan rated with AC 24 V on RDG160TU.
- Isolate the cables of inputs X1-M/X2-M and D1-GND if the conduit box carries AC 230 V mains voltage.
- On the RDG100.. and RDG110, inputs X1-M and X2-M carry mains potential. If the sensor's cables are extended, they must be suited for mains voltage.
- Inputs X1-M, X2-M or D1-GND of different units (e.g. summer/winter switch) may be connected in parallel with an external switch. Consider overall maximum contact sensing current for switch rating.
- Selectable relay function (RDG160T..). Consider overall maximum current through the relays.
- Disconnect power supply before removing the thermostat from the mounting plate!



Commissioning	<ol style="list-style-type: none"> 1. Select the application via the DIP switches at the rear of thermostat before fitting the front panel to the mounting plate. 2. Power up the thermostat after successfully connecting the line power. The thermostat starts to reset and all LCD segments flash, indicating that the reset is correct. <p>After the reset, which takes about 3 seconds, the thermostat is ready for commissioning by qualified HVAC staff. The control parameters of the thermostat can be set to ensure optimum performance of the entire system (see section 4.15).</p>
Temperature unit selection wizard (Only for RDG110U/RDG160TU)	<p>The temperature unit selection wizard enables to select the preferable temperature unit display on thermostats between °C and °F.</p> <ol style="list-style-type: none"> 1. Rotate rotary knob to select the preferable temperature unit to be displayed and operated. 2. Confirm the selection by pressing button ✓ (OK), which leads the thermostat advance to normal operating page.
Notes	<ul style="list-style-type: none"> • Pressing button ↵ (Esc) does not confirm the temperature selection. • If the temperature unit is not selected, °C is used by default.
Control sequence	<ul style="list-style-type: none"> • The control sequence may need to be set via parameter P01 depending on the application. The factory setting for the 2-pipe application is "Cooling only"; and "Heating and cooling" for the 4-pipe application.
Compressor-based application 	<ul style="list-style-type: none"> • When the thermostat is used in connection with a compressor, the minimum output on-time (parameter P48) and off-time (parameter P49) for Y11/Y21 must be adjusted to avoid damage to the compressor and shortening its life.
Calibrate sensor	<ul style="list-style-type: none"> • Recalibrate the temperature sensor if the room temperature displayed on the thermostat does not match the room temperature measured. To do this, change parameter P05.
Adaptive temperature compensation for electric heater	<ul style="list-style-type: none"> • When an electric heater is connected directly to output Y21, the rated current of the electric heating should be entered in parameter 46 (<i>RDG110 only, device index D and higher</i>), see section 4.8. Default setting: 1 A for loads ≤ 1 A.
Setpoint and setpoint setting range limitation	<ul style="list-style-type: none"> • We recommend to review the setpoints and setpoint setting ranges (parameters P08...P12) and change them as needed to achieve maximum comfort and save energy.

5.2 Operation

See also Operating Instructions (B3181.1) enclosed with the thermostat.

Layout

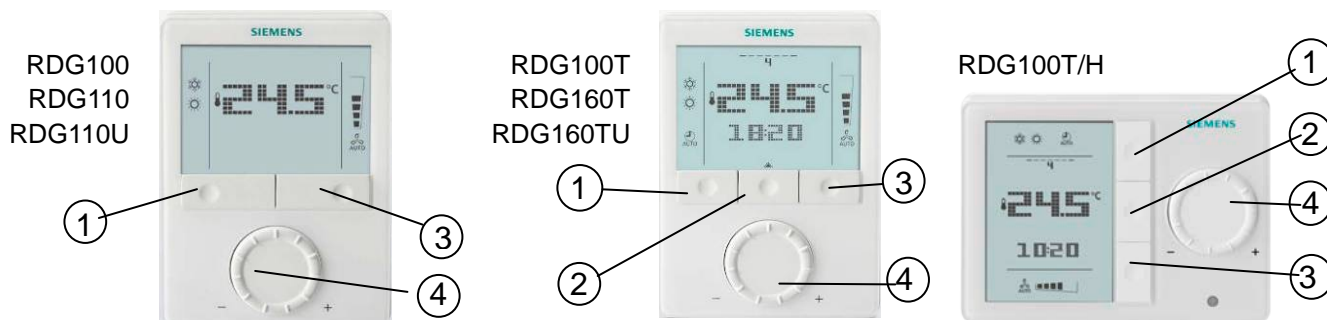

- 1 Operating mode button/Esc
- 2 Button to enter the time and to set the timers
- 3 Fan mode button/OK
- 4 Rotary knob for setpoint and parameter adjustment

Button operation

- When the thermostat is in normal operation, the actual operating mode and status are indicated by symbols.
- When a button is pressed, the thermostat goes into mode selection. The backlit LCD will turn on, all possible mode selection options (symbols) will turn on, indicator element (arrow) will appear on the current mode/status.
- When the button is pressed again, the indicator element will change to the next mode symbol and so on.
- After the last press and a timeout of 3 seconds, the newly selected mode is confirmed, the other elements disappear.
- After a timeout of 20 seconds, the LCD backlight will turn off.

User action	Effect, description
Press left button	Go into Operating mode selection
Press left button >3 seconds	Set thermostat to Protection mode
Keep left button depressed and turn rotary knob clockwise	Activate temporary timer "Extend presence" and set the time (for details, see page 22)
Keep left button depressed and turn rotary knob counterclockwise	Activate temporary timer "Extend absence" and set the time (for details, see page 22)
Press left button while "Operating mode switchover" is activated	Activate "Extend Comfort mode" (for details, see page 22)
Press right button >3 seconds	Activate/deactivate button lock
Press right button for fan coil unit	Change fan mode
Press right button for chilled ceiling (P52=0)	Set thermostat to Protection mode
Turn rotary knob	Adjust the room temperature setpoint
Press left and right button >3 seconds, release, then press right button >3 seconds	Go to parameter setting mode Service level
Press left and right button for 3 seconds, release, press left button for 3 seconds, then turn rotary knob counterclockwise min. ½ rotation	Go to parameter setting mode Expert level, diagnostics and test









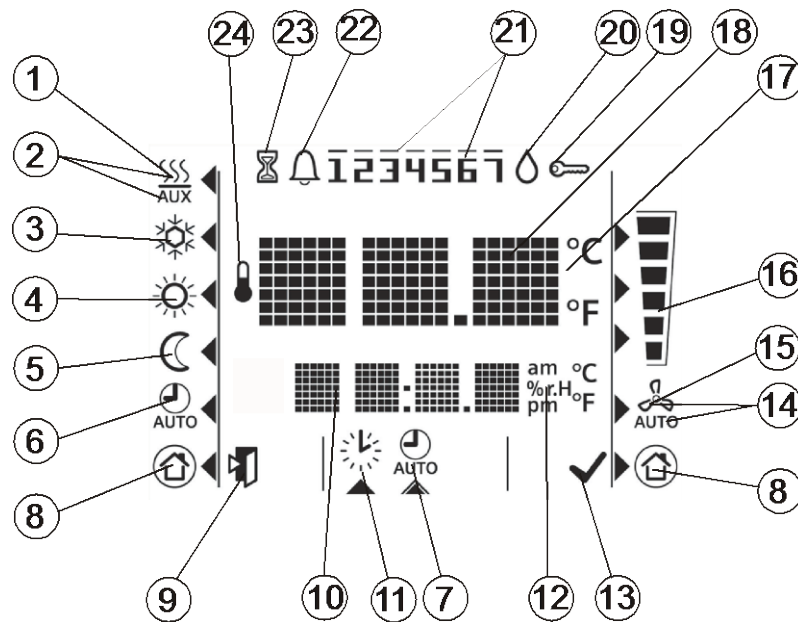

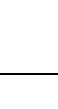

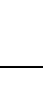







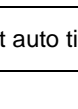

Only on RDG100T, RDG100T/H and RDG160T..:

Press center button	Go to timer settings
Press center button	Switch ON backlight if timer settings is disable (RDG160T..)

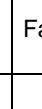
Buttons of the
RDG100T/H
LCD

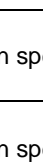
Button ✓ = bottom, button  = top (see operating instructions B3181.4).

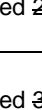
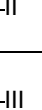

#	Symbol	Description	#	Symbol	Description
1		Heating mode	14		Automatic fan
2		Electric heater active	15		Manual fan
3		Cooling mode	16		 Fan speed 1-II
4		Comfort mode			 Fan speed 2-II
5		Economy mode			 Fan speed 3-III
6		Auto Timer mode	17		Degrees Celsius
7		View and set auto timer program			Degrees Fahrenheit
8		Protection	18		Digits for room temperature and setpoint display
9		Escape	19		Button lock
10		Digits for time of day, room temperature, setpoint, etc.	20		Condensation in room (dewpoint sensor active)
11		Setting the time of day and the weekday	21		Weekday 1...7: 1 = Monday/7 = Sunday
12		Morning: 12-hour format Afternoon: 12-hour format	22		Fault
			23		Temporary timer function (visible when operating mode is temporarily extended due to extended presence or absence)
13		Confirmation of parameters	24		Indicates that room temperature is displayed

5.3 Disposal



The devices are considered electronics devices for disposal in terms of European Directive 2012/19/EU and may not be disposed of as domestic waste.

- Dispose of the device via the channels provided for this purpose.
- Comply with all local and currently applicable laws and regulations.

6 Engineering

6.1 Connection terminals

RDG100,
RDG100T,
RDG100T/H

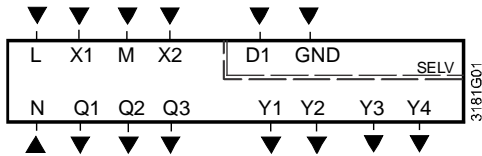

L, N Operating voltage AC 230 V

G, G0 Operating voltage AC/DC 24 V

Note: For DC 24 V: G0 = -; G = +

X1, X2 Multifunctional input for temperature sensor (e.g. QAH11.1) or potential-free switch

Factory setting :

- X1 = external room temperature sensor
- X2 = sensor or switch for heating/cooling changeover

Change of setting: Parameters P38, P40

M Measuring neutral for sensor and switch

D1, GND Multifunctional input for potential-free switch.

Factory setting: Operating mode switchover contact

Change of setting: Parameter P42

Q1 Control output fan speed "low"

Q2 Control output fan speed "medium"

Q3 Control output fan speed "high"

RDG110

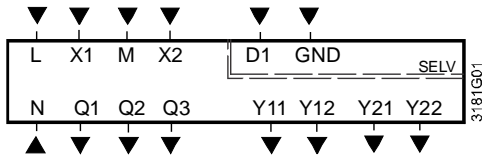

Y1...Y4 Control output "Valve" AC 230 V (NO, for normally open valves), output for electric heater via external relay

Y11, Y21 Control output "Valve" AC 230 V for RDG110
Control output "Valve" AC 24 V for RDG110U (NO, for normally open valves), output for compressor or electric heater

Y12, Y22 Control output "Valve" AC 230 V for RDG110
Control output "Valve" AC 24 V for RDG110U (NC, for normally closed valves)

RDG110U

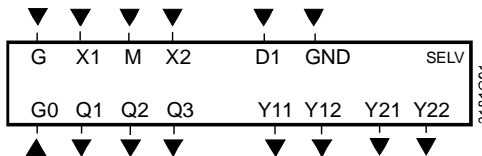

RDG160T

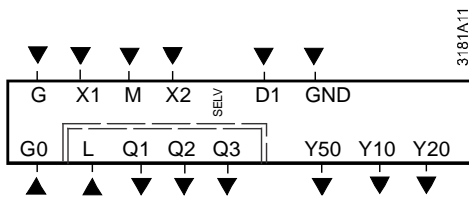

G, G0 Operating voltage AC/DC 24 V

Note: For DC 24 V: G0 = -; G = +

L (-N) Power supply relay output Q1...3
AC 24...230 V for RDG160T

Y10, Y20 Control output for DC 0...10 V actuator

Y50 Control output "Fan" DC 0...10 V

Q1...3 Control output fan, valve, electric heater or ex. equipment

RDG160TU

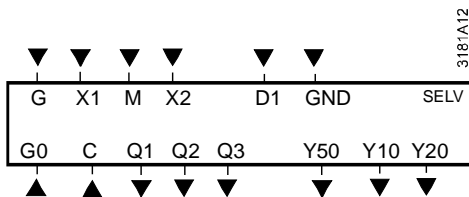

C (-G0) Power supply relay output Q1...3
AC 24 V for RDG160TU

6.2 Connection diagrams

Note For details concerning connection of peripheral devices and setting of the DIP switches, please refer to Mounting Instructions:

- [4] M3181.1 (RDG100, RDG100T)
- [5] M3181.2 (RDG110)
- [7] M3181.4 (RDG100T/H)
- [6] M3181.5 (RDG160T)
- [9] M3183.1 (RDG110U)
- [10] M3183.2 (RDG160TU)

RDG100..

Application

- 2-pipe

YHC

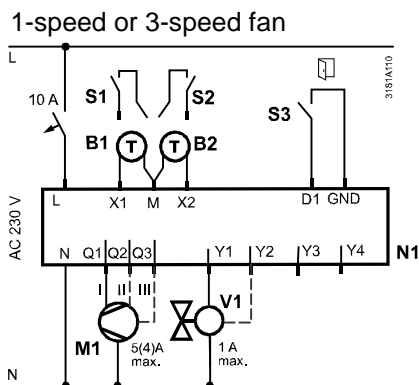

N1 Room thermostat RDG100..

M1 1-speed or 3-speed fan

V Valve actuators:

On/Off, heating, cooling, radiator, heating/cooling, 1st or 2nd stage

S1, S2 Switch (keycard, window contact, etc.)

S3 Switch at SELV input (keycard, window contact)

B1, B2 Temperature sensor (return air temperature, external room temperature, changeover sensor, floor temperature limit, etc.)

Q Relay outputs

Y1...Y4 Triac outputs

YH Heating valve actuator

YC Cooling valve actuator

YHC Heating/cooling valve actuator

YR Radiator valve actuator

YE Electric heater with relay/contactors Y

YHC1/YHC2 1st/2nd stage

- 2-pipe and radiator
- 4-pipe
- 2-stage

YHC YR
YH YC
YHC1 YHC2

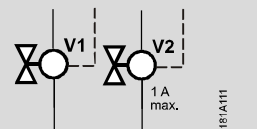

- 2-pipe and electric heater

YHC YE

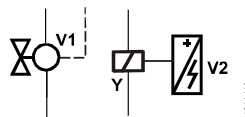

- 4-pipe and electric heater

YH YC
YE

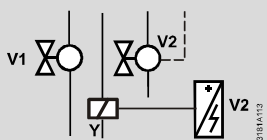

RDG110

Application

1-speed or 3-speed fan

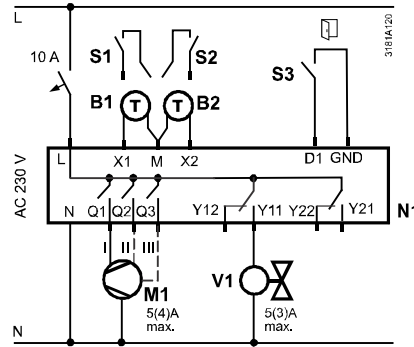

- 2-pipe

YHC

- 2-pipe and radiator
- 4-pipe
- 2-stage

YHC YR
YH YC
YHC1 YHC2

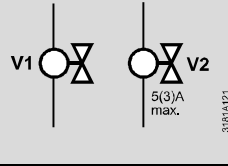

- 2-pipe and electric heater

YHC YE

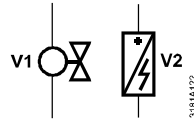

- 1st and 2nd stage compressor

C1 C2

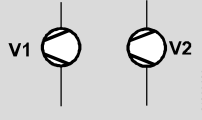

- Compressor and electric heater

C1 YE

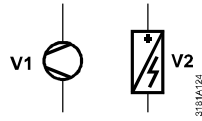

- Compressor and reversing valve

RV C1

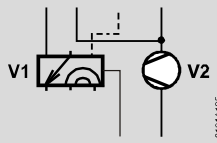

- N1 Room thermostat RDG110
- M1 1-speed or 3-speed fan
- V Valve actuators:
On/Off, heating, cooling, radiator, heating/cooling, 1st or 2nd stage
- S1, S2 Switch (keycard, window contact, etc.)
- S3 Switch at SELV input (keycard, window contact)
- B1, B2 Temperature sensor (return air temperature, external room temperature, changeover sensor, floor temperature limit, etc.)
- Q Relay outputs
- Y11...Y22 Relay outputs
- YH Heating valve actuator
- YC Cooling valve actuator
- YHC Heating/cooling valve actuator
- YR Radiator valve actuator
- YE Electric heater max. 5 A
- YHC1/YHC2 1st/2nd stage
- C1/C2 Compressor 1st and 2nd stage
- RV Reversing valve

RDG110U

Application

1-speed or 3-speed fan

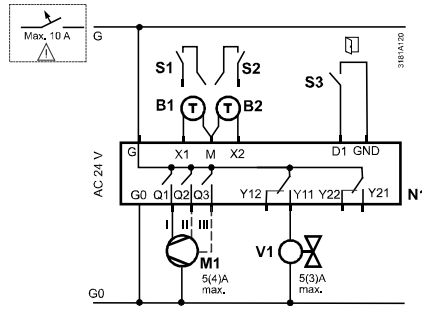

- 2-pipe

YHC

- 2-pipe and radiator
- 4-pipe
- 2-stage

YHC YR
YH YC
YHC1 YHC2

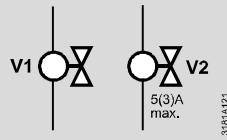

- 2-pipe and electric heater

YHC YE

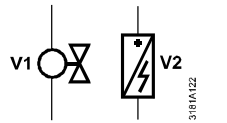

- 1 and 2-stage compressor

C1 C2

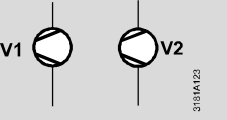

- Compressor and electric heater

C1 YE

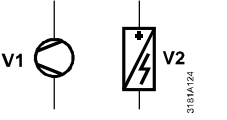

- Compressor and reversing valve

RV C1

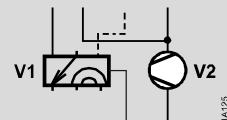

- N1 Room thermostat RDG110U
- M1 1-speed or 3-speed fan
- V Valve actuators:
On/Off, heating, cooling, radiator, heating/cooling, 1st or 2nd stage
- S1, S2 Switch (keycard, window contact, etc.)
- S3 Switch at SELV input (keycard, window contact)
- B1, B2 Temperature sensor (return air temperature, external room temperature, changeover sensor, floor temperature limit, etc.)
- Q Relay outputs
- Y11...Y22 Relay outputs
- YH Heating valve actuator
- YC Cooling valve actuator
- YHC Heating/cooling valve actuator
- YR Radiator valve actuator
- YE Electric heater max. 5 A
- YHC1/YHC2 1st/2nd stage
- C1/C2 Compressor 1st and 2nd stage
- RV Reversing valve

⚠ For US installations, use Class 2 rated power supplies.
For other installations, use circuit breakers with rated current of no more than 10 A.

RDG160T

DC 0...10 V fan

1-speed/3-speed fan

Application **V1** **V2**
 ↓ ↓ ↓

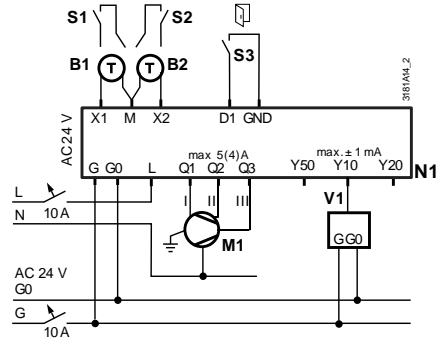
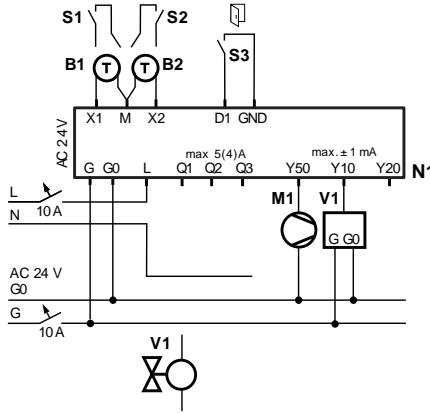

- 2-pipe YHC



- 2-pipe and radiator YHC YR
- 4-pipe YH YC
- 2-stage YHC1 YHC2

Q1 Q2 Y10 Y20 Y10 Y20

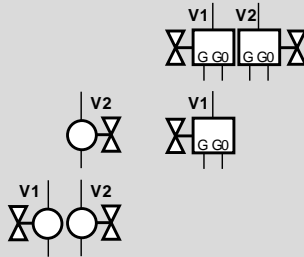

- 2-pipe and electric heater YHC YE

Q1 Q2 Y10 Y20 Y10 Y20

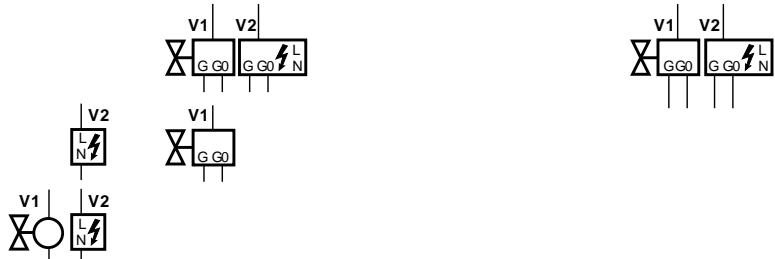

- Compressor C1
- Compressor 1-stage
- Compressor 2-stage C1 C2

Q1 Q2 Y10 Y20

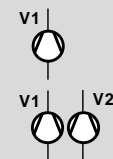

N1	Room thermostat RDG160T	M1	1-speed or 3-speed fan, DC 0...10 V fan
S1...S3	Switch (keycard, window contact, presence detector, etc.)	V1, V2	Valve actuators: On/Off, DC 0...10 V, heating, cooling, radiator, 1 st or 2 nd stage
B1, B2	Temperature sensor (return air temperature, external room temperature, changeover sensor, etc.)	YH	Heating valve actuator
YE	Electric heater max. 5 A	YC	Cooling valve actuator
C1, C2	Compressor 1 st /2 nd stage	YHC	Heating/cooling valve actuator
		YR	Radiator valve actuator
		YHC1/YHC2	1 st /2 nd stage

RDG160TU

DC 0...10 V fan

1-speed/3-speed fan

Application **V1** **V2**
 ↓ ↓

• 2-pipe YHC

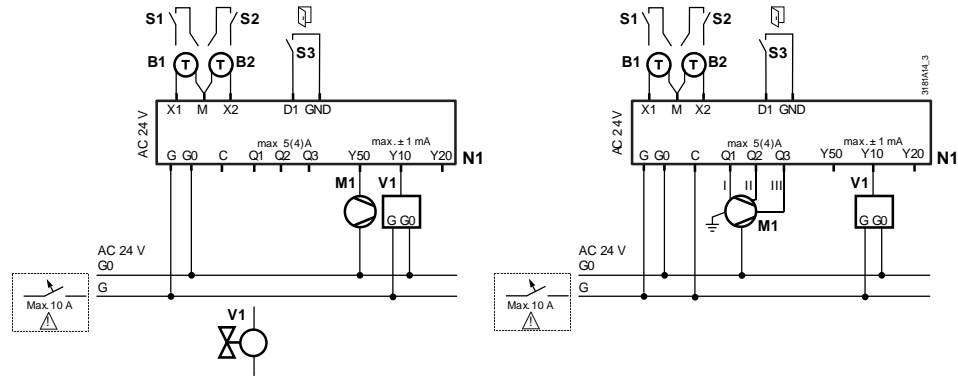

- 2-pipe and radiator YHC YR
- 4-pipe YH YC
- 2-stage YHC1 YHC2

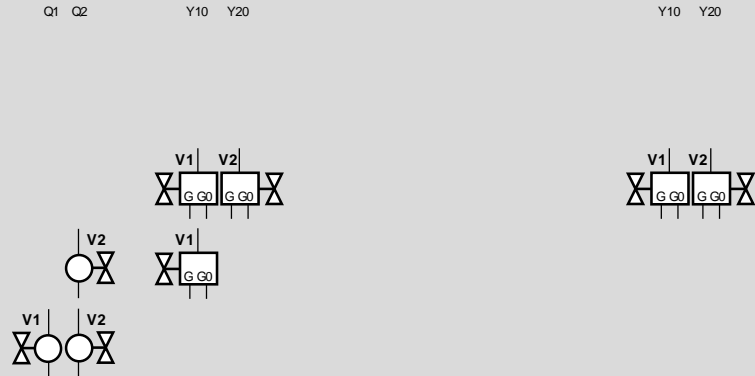

- 2-pipe and electric heater YHC YE

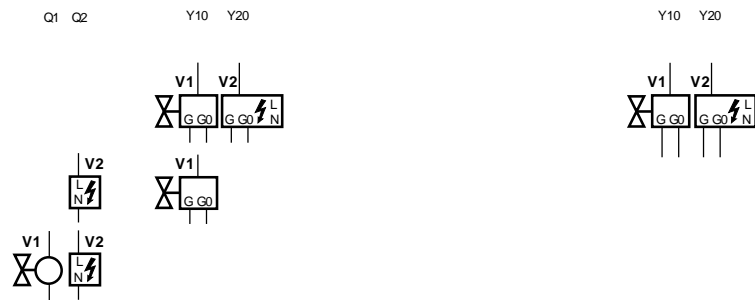

- Compressor YHC1 1-stage
- Compressor YHC1 YHC2 2-stage

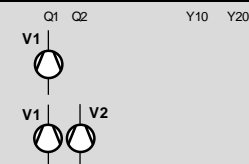

- | | | | |
|---------|---|-----------|--|
| N1 | Room thermostat RDG160TU | M1 | 1-speed or 3-speed fan, DC 0...10 V fan |
| S1...S3 | Switch (keycard, window contact, presence detector, etc.) | V1, V2 | Valve actuators: On/Off, DC 0...10 V, heating, cooling, radiator, 1 st or 2 nd stage |
| B1, B2 | Temperature sensor (return air temperature, external room temperature, changeover sensor, etc.) | YH | Heating valve actuator |
| YR | Radiator valve actuator | YC | Cooling valve actuator |
| YE | Electric heater max. 5 A | YHC | Heating/cooling valve actuator |
| | | YHC1/YHC2 | 1 st /2 nd stage |

⚠ For US installations, use Class 2 rated power supplies.
 For other installations, use circuit breakers with rated current of no more than 10 A.

7 Mechanical design

7.1 General

The room thermostat consists of 2 parts:

- Plastic housing which accommodates the electronics, the operating elements and the temperature sensor
- Mounting plate with the screw terminals

The housing engages in the mounting plate and is secured with 2 screws on the left side.



RDG100
RDG110
RDG110U



RDG100T
RDG160T
RDG160TU



RDG100T/H

For operation, refer to section 5.2.

7.2 Dimensions

RDG1..

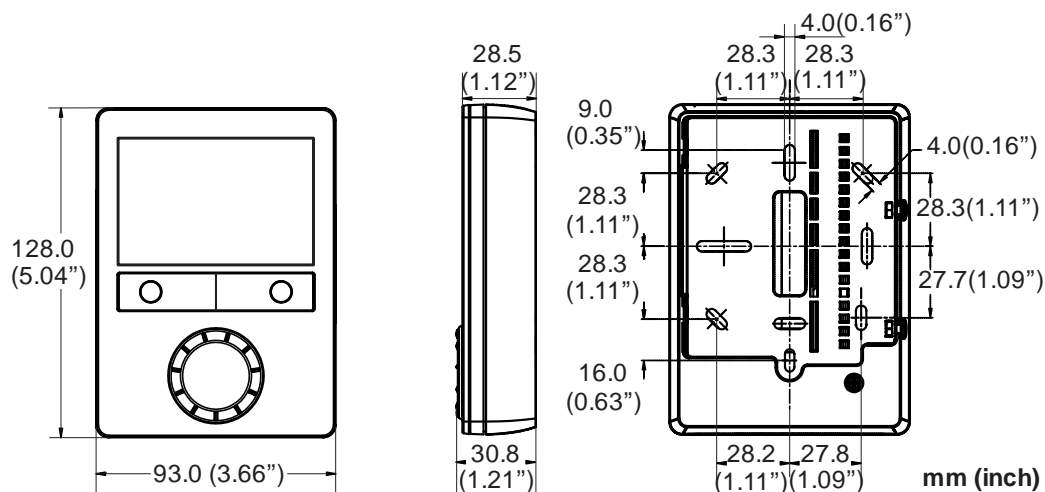

RDG100T/H

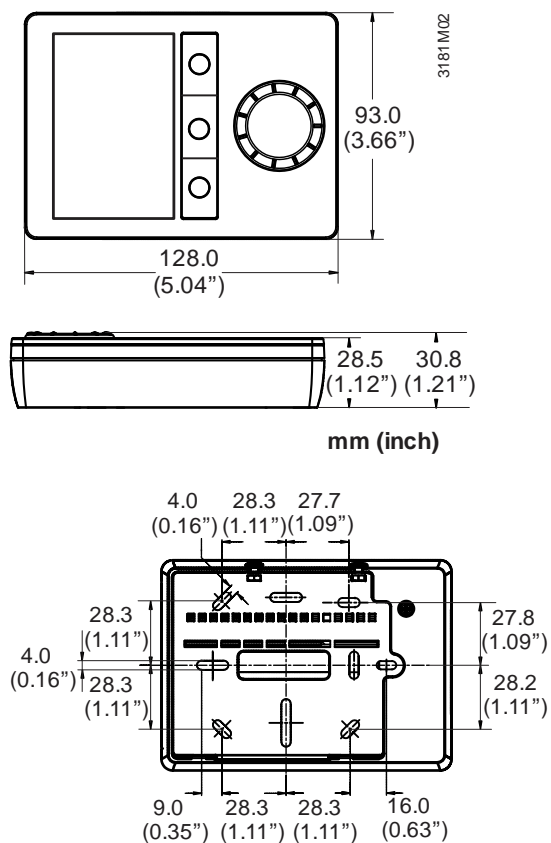

8 Technical data

RDG100../RDG110

 Power supply

Rated voltage	AC 230 V
Frequency	50/60 Hz
Power consumption	RDG100.. Max. 8 VA/1 W RDG110 Max. 12 VA/2 W



No internal fuse.
External preliminary protection with max. C 10 A circuit breaker required in all cases.

Outputs

Fan control Q1, Q2, Q3-N	AC 230 V
Rating min, max resistive (inductive)	AC 5 mA...5(4) A



Note!

Fans must NOT be connected in parallel!

Connect one fan directly, for additional fans, one relay for each speed.

Control outputs

Y1, Y2, Y3, Y4-N	RDG100.. AC 230 V, AC 8 mA...1 A
Power limitation	3A fast microfuse, cannot be exchanged

Y11-N/Y21-N (NO)	RDG110 AC 230 V, AC 5 mA...5(3) A
------------------	-----------------------------------



No internal fuse
External preliminary protection with max. C 10 A circuit breaker in the supply line required under all circumstances

Inputs

Multifunctional inputs

X1-M/X2-M

Temperature sensor input

Type	NTC (3 k Ω at 25 °C)
Temperature range	0...49 °C
Cable length	Max. 80 m

Digital input

Operating action	Selectable (NO/NC)
Contact sensing	DC 0...5 V, max. 5 mA
Parallel connection of several thermostats for one switch	Max. 20 thermostats per switch.
Insulation against mains	Do not mix with D1! N/A, mains potential 

D1-GND

Operating action	Selectable (NO/NC)
Contact sensing	SELV DC 6...15 V, 3...6 mA
Parallel connection of several thermostats for one switch	Max. 20 thermostats per switch.
Insulation against mains	Do not mix with X1/X2! 3.75 kV, reinforced insulation

Function input

External temperature sensor, changeover sensor, operating mode switchover contact, dewpoint monitor contact, enable electric heater contact, fault contact

Selectable

RDG110U

 Power supply

Rated voltage	SELV AC/DC 24 V or AC/DC 24 V class 2 (US)
DC 24 V: connect G to + and G0 to -	50/60 Hz
Frequency	Max. 2 VA/1 W
Power consumption	Circuit breaker max. 10 A Characteristic B, C, D according to EN 60898
External supply line protection (EU)	or Power source with current limitation of max. 10 A



No internal fuse.
External preliminary protection with max. C 10 A circuit breaker required in all cases.

Outputs

Fan control Q1, Q2, Q3-G0	AC 24 V
Rating min, max resistive (inductive)	AC 5 mA...5(4) A

 Note!

Fans must NOT be connected in parallel!

Connect one fan directly, for additional fans, one relay for each speed.

Control outputs

Y11-G0 /Y21-G0 (NO)	RDG110U	AC 24 V, AC 5 mA...5(3) A
---------------------	---------	---------------------------



No internal fuse.
External preliminary protection with max. C 10 A circuit breaker in the supply line required under all circumstances.

Inputs

Multifunctional inputs

X1-M/X2-M

Temperature sensor input

Type	NTC (3 k Ω at 25 °C (77 °F))
Temperature range	0...49 °C (32...120°F)
Cable length	Max. 80 m (262 feet)

Digital input

Operating action	Selectable (NO/NC)
Contact sensing	DC 0...5 V, max. 5 mA
Parallel connection of several thermostats for one switch	Max. 20 thermostats per switch. Do not mix with D1!
Insulation against mains	N/A, mains potential 

D1-GND

Operating action	Selectable (NO/NC)
Contact sensing	SELV DC 6...15 V, 3...6 mA
Parallel connection of several thermostats for one switch	Max. 20 thermostats per switch.

Do not mix with X1/X2!

Function input

External temperature sensor, changeover sensor, operating mode switchover contact, dewpoint monitor contact, enable electric heater contact, fault contact	Selectable
--	------------

RDG160T..

 Power supply

Rated voltage	SELV AC/DC 24 V
	or
DC 24 V: connect G to + and G0 to -	AC/DC 24 V class 2 (US)
Frequency	50/60 Hz
Power consumption	Max. 2 VA/1 W
External supply line protection (EU)	Circuit breaker max. 10 A Characteristic B, C, D according to EN 60898
	or
	Power source with current limitation of max. 10 A



No internal fuse.
External preliminary protection in G-G0 lines with max C 10 A circuit breaker
Required in all cases.

Outputs

Q1/Q2/Q3/L - N (relay)	RDG160T	AC 24...230 V
Q1/Q2/Q3/C - G0 (relay)	RDG160TU	AC 24 V class 2 (U.S.)

Use for 3-speed fan control

Rating min, max resistive (inductive) 5 mA...5(4) A



Note!

Fans must NOT be connected in parallel!

Connect one fan directly, for additional fans, one relay for each speed.

Use for actuator control (Q1, Q2)

Q1 - rating min, max resistive/inductive 5 mA...1 A
Q2 - rating min, max resistive (inductive) 5 mA...5(4) A
Max total load current Q1+Q2(+Q3) 5 A

Use for external equipment (Q1, Q2, Q3)

Rating min, max resistive/inductive Qx 5 mA...1 A
Max total load current Q1+Q2+Q3 2 A



No internal fuse
External preliminary protection in L line with max C 10 A circuit breakers
required in all cases.

Inputs

ECM fan control	Y50 - G0	SELV DC 0...10 V, Max. ± 5 mA
Actuator control	Y10 - G0/Y20 - G0 (G)	SELV DC 0...10 V, Max. ± 1 mA

Multifunctional inputs

X1-M/X2-M

Temperature sensor input





Type NTC (3 k Ω at 25 °C (77 °F))
Temperature range 0...49 °C (32...120 °F)
Cable length Max. 80 m (262 feet)

Digital input

Operating action Selectable (NO/NC)
Contact sensing DC 0...5 V, max. 5 mA
Parallel connection of several
thermostats for one switch Max. 20 thermostats per switch

D1-GND

Operating action Selectable (NO/NC)
Contact sensing DC 6...15 V, 3...6 mA
Parallel connection of several
thermostats for one switch Max. 20 thermostats per switch

Operational data, all types	Function of inputs		Selectable
	External room temperature sensor, heating/cooling changeover sensor, operating mode switchover contact, dewpoint monitor contact, enable electric heater contact, fault contact, monitoring input, supply air temperature		X1: P38 X2: P40 D1: P42
	Switching differential, adjustable		
	Heating mode	(P30)	2 K (0.5...6 K) 4 °F (1...12 °F)
	Cooling mode	(P31)	1 K (0.5...6 K) 2 °F (1...12 °F)
	Setpoint setting and setpoint range		
	 Comfort mode	(P08)	21 °C (5...40 °C) 70 °F (41...104 °F)
	 Economy mode	(P11-P12)	15 °C (59 °F)/30 °C (86 °F) OFF, 5...40 °C (41...104 °F)
	 Protection mode	(P65-P66)	8 °C (46 °F)/OFF OFF, 5...40 °C (41...104 °F)
	Multifunctional inputs X1/X2/D1		Selectable
Input X1		Ext. temperature sensor (P38=1)	
Input X2		Changeover sensor (P40=2)	
Input D1		Operating mode switchover (P42=3)	
Environmental conditions	Built-in room temperature sensor		
	Measuring range		0...49 °C (32...120 °F)
	Accuracy at 25 °C (77 °F)		< ± 0.5 K (± 1 °F)
	Temperature calibration range		± 3.0 K (± 6 °F)
	Settings and display resolution		
	Setpoints		0.5 °C (1 °F)
	Current temperature value displayed		0.5 °C (1 °F)
	Operation		As per IEC 60721-3-3
	Climatic conditions		Class 3K5
	Temperature		0...50 °C (32...122 °F)
Humidity		<95% r.h.	
Transport		As per IEC 60721-3-2	
Climatic conditions		Class 2K3	
Temperature		-25...65 °C (-13...149 °F)	
Humidity		<95% r.h.	
Mechanical conditions		Class 2M2	
Storage		As per IEC 60721-3-1	
Climatic conditions		Class 1K3	
Temperature		-25...65 °C (-13...149 °F)	
Humidity		<95% r.h.	
Standards	EU Conformity (CE)		CE1T3181xx ^{*)}
	Electronic control type		2.B (micro-disconnection on operation)
	 RCM conformity		CE1T3181xx_C1 ^{*)}
	 UL (RDG110U/RDG160TU)		UL 916 PAZX CSA-C22.2 No. 205 PAZX7 http://database.ul.com
	Safety class	RDG160T RDG160TU	II as per EN60730 III as per EN60730
	Pollution class		Normal
	Degree of protection of housing		IP30 to EN60529

Environmental Compatibility	The product environmental declaration CE1E3181 and CE1E3181_1 ^{*)} contains data on environmentally compatible product design and assessments (RoHS compliance, materials composition, packaging, environmental benefit, disposal).	
General	Connection terminals	Solid wires or prepared stranded wires 1 x 0.4...2.5 mm ² (14 gauge) or 2 x 0.4...1.5 mm ² (16 gauge)
	Note: For sensors on inputs X1, X2, or D1, the cable length is max. 80 m (262 feet).	
	Wiring cross section on L, N, Q1, Q2, Q3, Y1, Y2, Y3, Y4, Y11, Y21	Min, 1.5 mm ² (16 gauge)
	Housing front color	RAL 9003 white
Weight	RDG100../RDG110..	0.30 kg
	RDG160T..	0.32 kg

*) The documents can be downloaded from <http://siemens.com/bt/download>.

Index

0

0...10 V → DC 0...10 V 43

1

1-/3-speed fan 43

12-hour and 24-hour format 49

1-speed fan 45

3

3-position control signal 40

3-speed fan 45

A

Absence 23

Adaptive temperature compensation 41

Applications overview 17

Auto Timer mode 13, 49

Automatic heating/cooling changeover 20, 26

B

Backlit LCD 7

Basic application 38

Button lock 23

C

Cable length for sensors 49

Chilled/heated ceiling applications 38

Clean fan filter reminder 47

Comfort mode 13

Comfort setpoint 14

Compressor applications 38

Control outputs 7

Control outputs overview 27

Control parameters 53

Control sequences 26

Cooling sequence 26

D

DC 0...10 V fan 45

DC 0...10 V valves 45

DC 0...10 V 43

DC 0...10 V control signal 40

DC 0...10 V for electric heaters 42

DC 0...10 V for valve actuators 42

Default timer settings 51

Dewpoint monitor 48

Dewpoint monitoring 22

Diagnostics and test 53

Digital input 48

DIP switches 52

Disposal 65

E

ECM fan 45

ECM-Ventilator 7

Economy mode 13

Electric heater 29

Enable/disable electric heater 29, 34, 48

Expert level parameters 53

Extend Comfort mode 23

Extension of presence/absence 23

External/return air temperature 48

External/return air temperature sensor 20

F

Fan in Auto Timer mode 47

Fan in dead zone 54, 57

Fan kick 46

Fan kick function 46

Fan minimum on-time 46

Fan operation as per heating/cooling mode, or

disabled 45

Fan operation in dead zone 46

Fan overrun 46

Fan start 46

Fan start delay 47

Fault 48

Fault, handling 52

Floor cooling 21

Floor heating 21

Floor temperature limitation function 21

H

Heating and cooling mode 26

Heating mode 26

Heating/cooling changeover 20, 48

I

Infrared receiver 7

Infrared remote control 52

Integral action time 12

L

LCD 64

LCD, backlit 7

M

Main and secondary 32

Manual heating/cooling changeover 20

Manually select heating or cooling sequence 26

Minimum output 21

Moisture	21	Resetting parameters	53
Mounting and installation	61	Reversing valve	39
Multifunctional inputs	48		
O		S	
On/off control signal	40	Sensor input	48
Operating mode button	13	Setpoint Comfort mode	15
Operating mode input	13	Setpoint Economy mode	15
Operating mode switchover	48	Setpoint limitation	14
Operating voltage	7	Setpoint Protection mode	15
Overlapping of timer sequences	51	Setpoints and sequences	15
		Setting the time of day and the weekday	49
P		Setting the timers	50
Parallel connection of switches	49	Standby/Protection mode	13
Parameter setting	53	Supply air temperature limitation	22
Power failure	50	Switch off external equipment	25
Presence	23	Switching differential	12
Programmable timers	49	Synchronization	41
Proportional band	12	T	
Protection mode/Standby	13	Temperature out of range	52
Purge function	20	Temporary setpoint	14
PWM	40	Time program	7
PWM for electric heater	41		
R		V	
Radiator	31	View programmable settings	50
Radiator applications	38	W	
Reloading default timer settings	51	Window contact	23
Remote heating/cooling changeover	20		



Institut
Automatització, S.L.

c\ Gomis, 29-33, 08023 BARCELONA

Tel.: 93 454 20 06
Fax: 93 323 70 59

iac@instauto.com
www.instauto.com

www.
TODO-
CONTROL.com
SOLUCIONES PARA AUTOMATIZACIÓN Y CLIMATIZACIÓN

© 2016 Siemens Switzerland Ltd.
Subject to change