

7794 DVP Sanitary Durafet[®] III pH Electrode Series Instruction Manual

70-82-25-118

Rev. 1

1/04

Copyright, Notices, and Trademarks

Printed in U.S.A. – © Copyright 2004 by Honeywell

Revision 1 – January, 2004

WARRANTY/REMEDY

Honeywell warrants goods of its manufacture as being free of defective materials and faulty workmanship. Contact your local sales office for warranty information. If warranted goods are returned to Honeywell during the period of coverage, Honeywell will repair or replace without charge those items it finds defective. The foregoing is Buyer's sole remedy and is **in lieu of all other warranties, expressed or implied, including those of merchantability and fitness for a particular purpose.** Specifications may change without notice. The information we supply is believed to be accurate and reliable as of this printing. However, we assume no responsibility for its use.

While we provide application assistance personally, through our literature and the Honeywell web site, it is up to the customer to determine the suitability of the product in the application.

Industrial Measurement and Control

Honeywell
1100 Virginia Drive
Fort Washington, PA 19034

About This Document

Abstract

This manual is published solely for the purpose of supporting the 7794 Sanitary Durafet III pH Electrode.

Contacts

World Wide Web

The following lists Honeywell's World Wide Web sites that will be of interest to our customers.

Honeywell Organization	WWW Address (URL)
Corporate	http://www.honeywell.com
Industrial Measurement and Control	http://www.honeywell.com/imc
International	http://www.honeywell.com/Business/global.asp













Telephone

Contact us by telephone at the numbers listed below.

	Organization	Phone Number
United States and Canada	Honeywell	1-800-423-9883 Tech. Support 1-888-423-9883 Q&A Faxback 1-800-525-7439 (TACFACS) Service
Asia Pacific	Honeywell Asia Pacific Hong Kong	(852) 2829-8298
Europe	Honeywell PACE, Brussels, Belgium	[32-2] 728-2111
Latin America	Honeywell, Sunrise, Florida U.S.A.	(854) 845-2600

Symbol Definitions

The following table lists those symbols that may be used in this document to denote certain conditions.

Symbol	Definition
	This DANGER symbol indicates an imminently hazardous situation, which, if not avoided, will result in death or serious injury .
	This WARNING symbol indicates a potentially hazardous situation, which, if not avoided, could result in death or serious injury .
	This CAUTION symbol may be present on Control Product instrumentation and literature. If present on a product, the user must consult the appropriate part of the accompanying product literature for more information.
	This CAUTION symbol indicates a potentially hazardous situation, which, if not avoided, may result in property damage .
	WARNING PERSONAL INJURY: Risk of electrical shock. This symbol warns the user of a potential shock hazard where HAZARDOUS LIVE voltages greater than 30 Vrms, 42.4 Vpeak, or 60 Vdc may be accessible. Failure to comply with these instructions could result in death or serious injury.
	ATTENTION, Electrostatic Discharge (ESD) hazards. Observe precautions for handling electrostatic sensitive devices
	Protective Earth (PE) terminal. Provided for connection of the protective earth (green or green/yellow) supply system conductor.
	Functional earth terminal. Used for non-safety purposes such as noise immunity improvement. NOTE: This connection shall be bonded to protective earth at the source of supply in accordance with national local electrical code requirements.
	Earth Ground. Functional earth connection. NOTE: This connection shall be bonded to Protective earth at the source of supply in accordance with national and local electrical code requirements.
	Chassis Ground. Identifies a connection to the chassis or frame of the equipment shall be bonded to Protective Earth at the source of supply in accordance with national and local electrical code requirements.
	Earth Ground. Functional earth connection. NOTE: This connection shall be bonded to Protective earth at the source of supply in accordance with national and local electrical code requirements.
	Chassis Ground. Identifies a connection to the chassis or frame of the equipment shall be bonded to Protective Earth at the source of supply in accordance with national and local electrical code requirements.

Contents

1. INTRODUCTION	1
1.1 Description	1
1.2 Compatibility	2
1.3 Application Restrictions	3
1.4 Specifications	4
1.4.1 Sanitary Durafet III Electrode	4
2. INSTALLATION	5
2.1 Unpacking	5
2.2 General Precautions	5
2.3 Installing the Electrode	5
2.4 Connecting a Cap Adapter to an Instrument	8
2.4.1 Cap Adapter	8
2.4.2 Connection to a 9782 pH Analyzer	9
2.4.3 Connection to an APT2000 pH Transmitter	10
2.4.4 Connection to an APT4000 pH Analyzer	11
2.5 Connection to DirectLine Modules (Remote Mounting only)	12
2.6 Cable Connection	12
2.7 Electrode Removal	12
2.8 Calibration	12
3. MAINTENANCE	13
3.1 Shelf Life and Storage	13
3.2 Cleaning	13
3.3 Replacement and Accessory Parts	14

Tables

Table 1-1 Durafet III pH Electrode Flange Sizes	2
Table 3-1 Replacement and Accessory Parts	14

Figures

Figure 1-1 Sanitary Durafet III pH Electrode	2
Figure 2-1 Sanitary Durafet III Electrode Outline and Dimensions	6
Figure 2-2 Electrode Installation in Tee	8
Figure 2-3 Sensor Location	8
Figure 2-4 Connecting to an APT2000 pH Transmitter	10
Figure 2-5 Connecting to an APT4000 pH Analyzer	11

1. Introduction

1.1 Description

Honeywell introduces the Sanitary Durafet III pH electrode, a non-glass, unbreakable, ISFET (Ion Sensitive Field Effect Transistor) technology based pH sensor. The Sanitary Durafet III electrode is designed to meet 3-A Sanitary Standards. Solid state ISFET technology eliminates the conventional, fragile glass pH sensor. The unbreakable pH sensor can be inserted directly into the process without the fear of product contamination. pH measurement can be online and continuous—no time-consuming grab sampling is necessary. This pH electrode, with over 9 years of industry-proven application experience, provides fast, accurate and dependable pH measurement in the most demanding food and dairy applications.



The Sanitary Durafet III pH electrode has an integral, tri-clamp flange for easy mounting in the process. Cable options are available for remote mounting to the innovative Honeywell DirectLine® Sensor Module. It is also available with the Cap Adapter cable for connection to Honeywell instrumentation (APT and 9782 Series), as well as selected competitors' instrumentation. All cable options use the Vario Pin connector that provides an IP68, waterproof connection to the electrode.

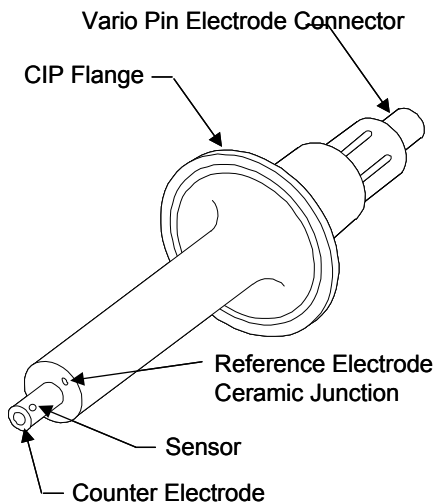

Figure 1-1 Sanitary Durafet III pH Electrode

There are six models in the Sanitary Durafet III Series product line with varying flange sizes and immersion depths (Table 1-1). See Figure 2-1 for complete dimensions.

Table 1-1 Durafet III pH Electrode Flange Sizes

Part number	Flange Diameter	Immersion Depth
51453535-001	1-1/2"	Shallow
51453535-002	1-1/2"	Deep
51453535-003	2"	Shallow
51453535-004	2"	Deep
51453535-005	3"	Shallow
51453535-006	3"	Deep

1.2 Compatibility

The Sanitary Durafet III Electrode Series can be used with various pH analyzers from Honeywell. The following types of pH Analyzers can be used.

- 9782P-01 Analyzers with pH input from Cap Adapter
- APT2000pH Transmitter with input from Cap Adapter
- APT4000pH Analyzer with input from Cap Adapter
- DirectLine pH Sensor Module, DL421 (remote mounting only)

1.3 Application Restrictions

The Sanitary Durafet III ISFET sensor lifetime is affected by exposure to hot caustic solutions that can be present in CIP cycles of Food and Dairy applications. The following graph can be used as a guideline to determine if the Sanitary Durafet III pH electrode should be taken out of the process during the cleaning cycle. For expected lifetime at specific temperatures and caustic concentrations based on exposure time contact your local Honeywell Sales representative.

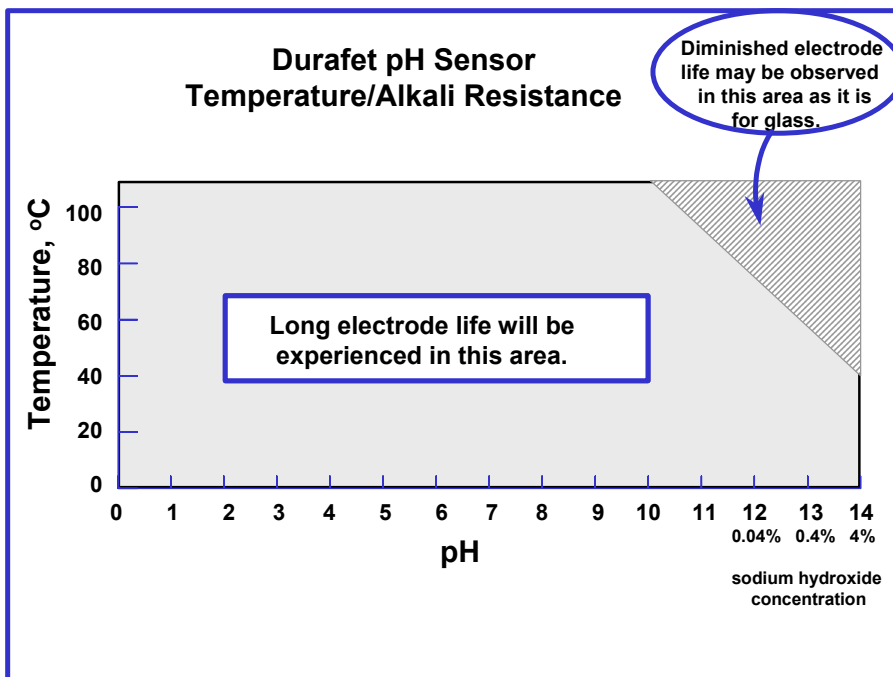

1.4 Specifications

1.4.1 Sanitary Durafet III Electrode

Operating Range:

0 pH to 14 pH

Operating Temperature Range:

-10 °C to 110 °C (+14 °F to 230 °F)

Sterilization conditions (non-operating):

130 °C maximum @ 345 KPa maximum (266 °F maximum @ 50 psig maximum)

Maximum Process Pressure:

0 KPa to 690 KPa from -10 °C to 100 °C
0 KPa to 345 KPa from above 100 °C
0 psig to 100 psig from 14 °F to 212 °F
0 psig to 50 psig above 212 °F

Body:

Fortron® and polysulfone, FDA compliant. Ceramic reference junction. ISFET measuring sensor.

Internal Reference:

Silver-silver chloride gel-filled diffusion type

Electrode Length:

See Figure 2-1.

Electrode Weight:

1-1/2": 6.4 oz. (181.7 grams)
2": 6.7 oz. (190.3 grams)
3": 7.0 oz. (229.9 grams)

Temperature Compensation:

Automatic

Connection:

Vario Pin, IP68 waterproof connector

Cables:

20' and 50' DirectLine Remote Durafet cables
20' and 50' Cap Adapter cables

Electrode Mounting:

Installs into standard sanitary (such as Tri-Clamp®) fittings.

Materials in Contact with Process Solution:

Polysulfone, Fortron®, Viton, high alumina ceramic, silicon

2. Installation

2.1 Unpacking

Examine the shipping container before opening. If there are visible signs of damage, do not open the container. Notify the carrier and Honeywell immediately. If there is no external damage, open the container and compare the contents with the packing list. Notify the carrier and Honeywell immediately if there is equipment damage or shortage.



Carefully remove the electrode from the shipping carton. Note the general precautions listed below prior to handling. Handle with care: Electrostatic discharge-sensitive devices inside the Cap Adapter and Sanitary Durafet III Electrode.

It is recommended that the soft vinyl protective covers be left in place on the electrode and flange until time of installation to avoid scratching or nicking the electrode surfaces. The cotton packing material inside the cap is saturated with water that protects the porous reference junction from drying during shipment and storage.

Note the electrical connector which is located above the label on the electrode. Leave the protective cap over the electrical connection end until you are ready to connect the electrode cable. Save the connector cap for protection whenever the electrode cable is disconnected.

2.2 General Precautions



- ESD-sensitive devices inside Cap Adapter and Sanitary Durafet III Electrode
- Avoid touching the sensor area. Pressure applied to this area could damage the sensor.
- Avoid contaminating the electrical connector contacts. Contamination can result in electrical leakage paths which affect the accuracy of pH measurements.
- Always replace the protective cap over the sensor when the electrode is not in use. Be sure to reinstall the electrode connector cap whenever the electrode is removed from service. Ensure that the cotton packing in the cap is saturated with water to prevent the reference junction from drying out.
- Do not install electrodes where temperatures go below $-10\text{ }^{\circ}\text{C}$ ($+14\text{ }^{\circ}\text{F}$) or freeze damage may result. Observe upper temperature limit specifications ($110\text{ }^{\circ}\text{C}$, $230\text{ }^{\circ}\text{F}$ operating).
- See “Electrode Installation” later in this manual for information on proper positioning of the electrode.
- Promptly remove any water that might inadvertently come in contact with the electrode connector or cable connector. Blow drying with clean low pressure (15 psi) instrument air is a simple and effective means for drying the connector(s).

2.3 Installing the Electrode

Be sure the location of the electrode allows sufficient space for removal. See Figure 2-1.

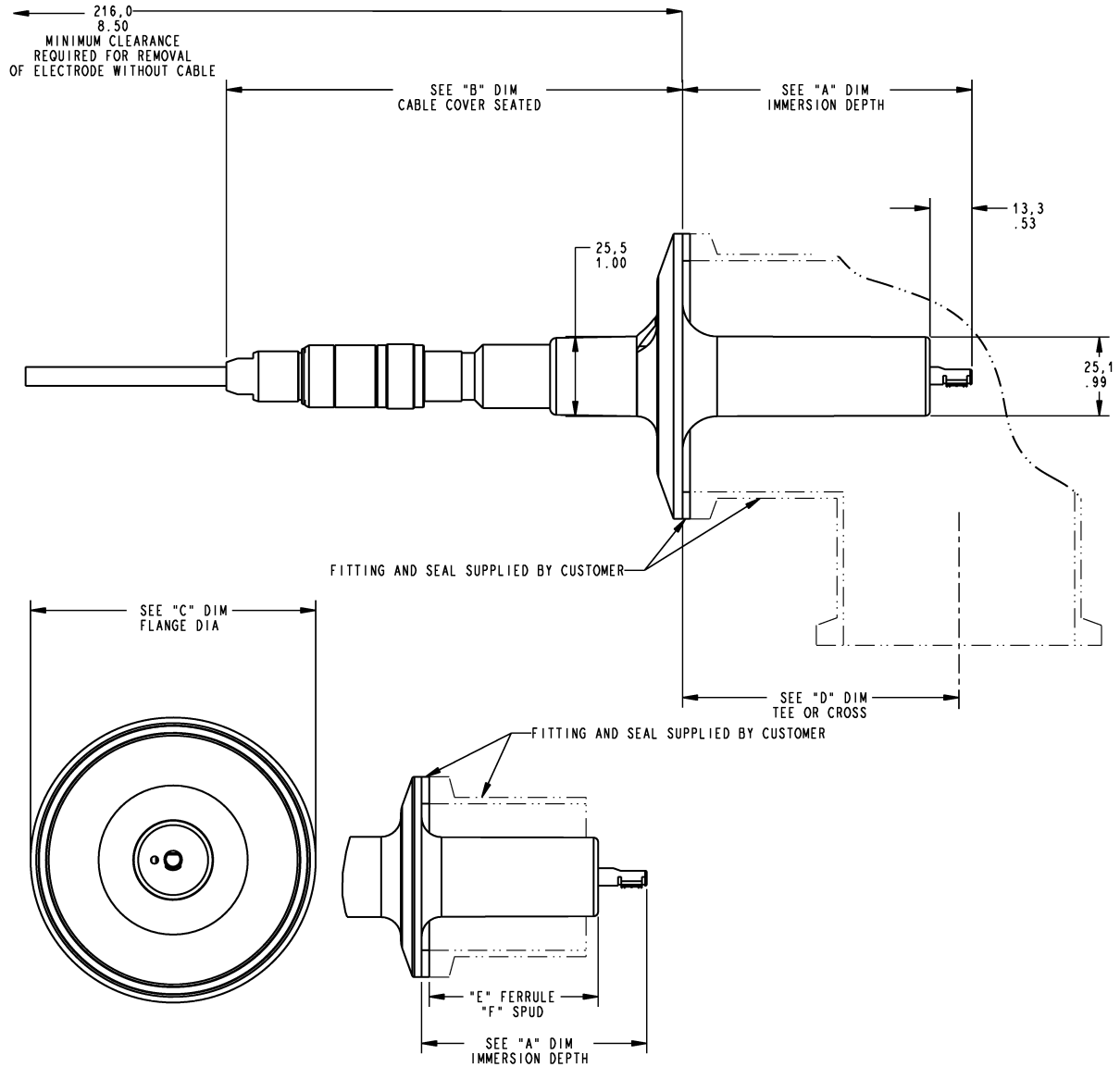

PART NO	CIP FLANGE	A DIM	B DIM	C DIM	D DIM	E DIM	F DIM
51453535-001	38,1 1.50	58,2 2.29	179,4 7.06	50,3 1.98	69,9 2.75	41,4 1.63	76,2 3.00
51453535-002		73,9 2.91	163,6 6.44				
51453535-003	50,8 2.00	71,9 2.83	165,6 6.52	64,0 2.52	88,9 3.50	44,5 1.75	76,2 3.00
51453535-004		94,5 3.72	143,0 5.63				
51453535-005	76,2 3.00	64,3 2.53	173,3 6.82	90,9 3.58	95,3 3.75	49,2 1.94	101,6 4.00
51453535-006		94,5 3.72	140,0 5.51				

Figure 2-1 Sanitary Durafet III Electrode Outline and Dimensions

Sanitary Durafet III electrodes are designed for installation with the following Tri-Clamp® (or equivalent) fittings:

- 7MP-1-1/2" Tee
- 7MP-2" Tee
- 7MP-3" Tee
- 14 MPW-1-1/2" Tank Welding Ferrule
- 14 MPW-2" Tank Welding Ferrule
- 14 MPW-3" Tank Welding Ferrule
- 14 WLMP-1-1/2" Tank Welding Spud
- 14 WLMP-2" Tank Welding Spud
- 14 WLMP-3" Tank Welding Spud
- 9 MP-1-1/2" Cross
- 9 MP-2" Cross
- 9 MP-3" Cross

The electrode assembly, as you receive it, has not been sanitized. Prior to installation, you must clean/sanitize the electrode assembly as your process requires.

If the electrode is being installed in a location which uses air-injected sanitary fittings, make sure that the electrode's maximum pressure/temperature limits are not exceeded. See Specifications.

To maintain electrode/sanitary fitting pressure and temperature service ratings, use heavy construction clamp/gasket combination (not supplied by Honeywell). Tri-Clamp series 13 MHHM or 13MHHS with wing nut tightened to 25 inch-lb. torque and Tri-Clamp series 40 MP EPDM, Viton torque and Tri-Clamp series 40MP EPDM, Viton or silicone rubber gaskets meet the requirements.

Owing to the nature of PTFE, it is strongly recommended that you not use this gasket material, as the possibility of leakage and damage to the electrode may occur.

Overtightening of the mounting clamp may damage the electrode.

Install electrode as follows:

1. Remove the soft vinyl protective covers from the electrode and flange.
2. Install the electrode, using a suitable gasket, in the appropriately sized Tri-Clamp® (or equivalent) fitting.

If the application permits, a suitable release agent may be applied to the gasket to aid in later electrode removal.

Because of cleanability considerations, avoid mounting the electrode vertically with the sensor end UP.

Vertical mounting with sensor end DOWN, or horizontal mounting are recommended. If you are installing the electrode in a tee, the electrode should be installed in one end of the "run", rather than the "branch". The product flow inlet should be in through the other end of the "run" and exit should be out through the branch (Figure 2-2).

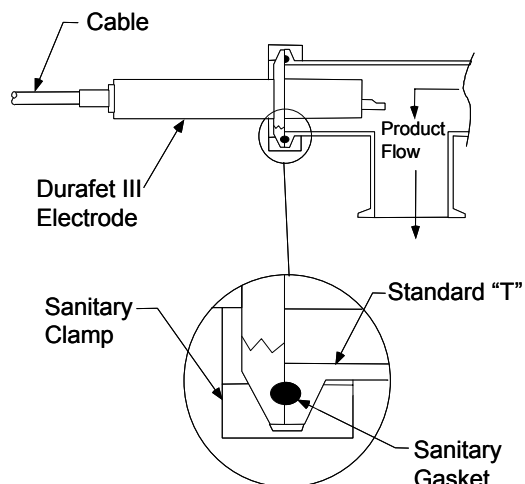

Figure 2-2 Electrode Installation in Tee

If you cannot avoid mounting the electrode in the branch of a tee, make sure the sensor is turned to face the oncoming process flow. However, if the process is abrasive (contains hard particulate matter), then rotate the electrode to turn the sensor to face away from the oncoming process flow.

NOTICE

The sensor is aligned with the “H” of the Honeywell logo on the electrode body (Figure 2-3). When the electrode is in its mounting, look at the position of the logo to determine the orientation of the electrode.

To remove the electrode, see Section 2.7.

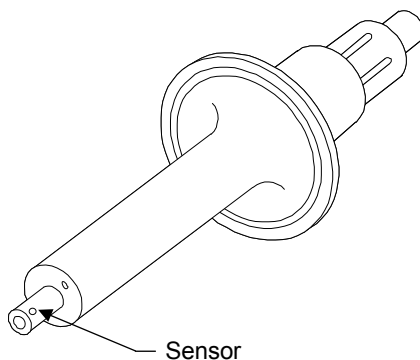

Figure 2-3 Sensor Location

2.4 Connecting a Cap Adapter to an Instrument

2.4.1 Cap Adapter

The Cap Adapter is an integral part of the electrode cable. It is essentially a preamplifier that does not require separate mounting. The output from the Cap Adapter can be connected directly to a pH instrument.

The Cap Adapter and cable for Durafet III electrodes are available in lengths of 20 feet and 50 feet. One end of the Cap Adapter cable is the Vario Pin mating connector to the Vario Pin connector of the Durafet III electrode. The other end of the cable terminates with tinned leads. The tinned leads connect to the input terminals of the pH instrument (Sections 2.4.2, 2.4.3, 2.4.4).

2.4.2 Connection to a 9782 pH Analyzer

The Cap Adapter is connected to a 9782P-01 analyzer. (See *Instruction Manual #70-82-25-73 "9782 pH/ORP Multifunction Analyzer/Controller"*, for a more detailed description of the 9782.) Connect the tinned leads of the Cap Adapter cable as follows:

Wire Color	9782 Terminal
Orange	PA
Blue	V+
Green	V-
White	SC
Black	SC
Red	TH
Yellow	Ground Screw
White/Black	Not Used
Red/Black	TH

2.4.3 Connection to an APT2000 pH Transmitter

The Cap Adapter can be connected to the APT2000 pH Transmitter. (See the *APT2000 pH Transmitter Manual*, part number 70-82-25-92, for more detailed description of the APT2000.)

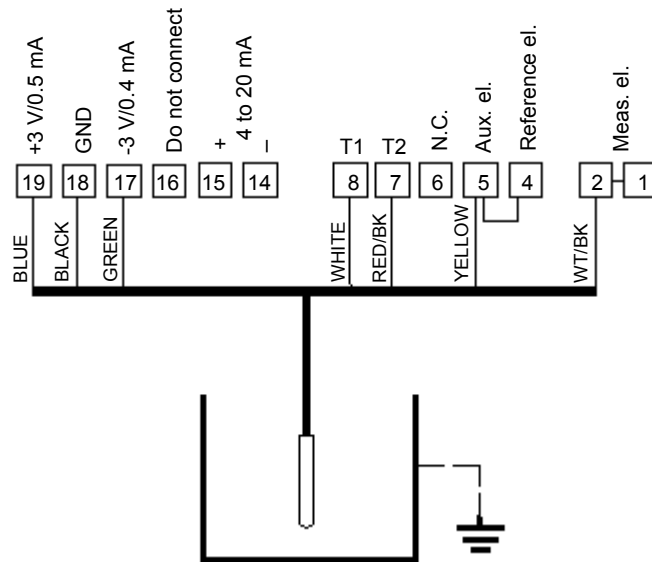

NOTE:

Orange and Red wires are not typically connected. These should be clipped and electrically sealed to avoid possible contact with other conductors.

Figure 2-4 Connecting to an APT2000 pH Transmitter

2.4.4 Connection to an APT4000 pH Analyzer

The Cap Adapter can be connected to the APT4000 pH Analyzer. (See the *APT4000 pH Analyzer Manual*, part number 70-82-25-103, for more detailed description of the APT4000.)

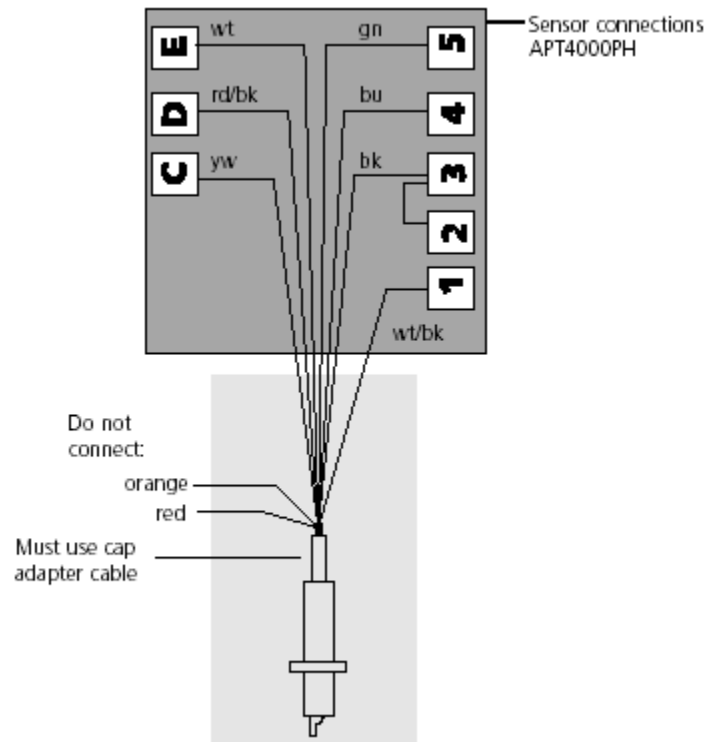

Figure 2-5 Connecting to an APT4000 pH Analyzer

2.5 Connection to DirectLine Modules (Remote Mounting only)

See Directline Model 421 manual (#70-82-25-102) for details.

2.6 Cable Connection

Make sure electrode connector and cable connector are clean and dry. Align keyway on Vario Pin connector of electrode with tab inside of mating connector on cable. Press cable connector onto electrode firmly. Tighten knurled bushing of cable connector by hand to ensure waterproof seal.

2.7 Electrode Removal

Before removing an electrode from a process, make sure the line in which it is installed has been emptied and that process pressure has been reduced to atmospheric pressure before removing the clamp.

Remove the electrode as follows:

1. Unscrew and disconnect the cable connector and place the protective cap on the electrode receptacle. (See Section 3.3 to reorder these caps, if necessary.)
2. Remove the sanitary clamp. Then grasp the back end of the electrode close to the flange, and gently rock it back and forth to separate it from the gasket. If the gasket sticks, allow 4 to 5 minutes for it to relax, then try again. Do not strike the electrode or flange with a hammer/mallet, etc., and do not pull the electrode sharply to the side, as these actions can damage the unit. The gasket is more likely to stick after the joint has been heated and cooled.

If the application permits, a suitable release agent may be applied to the gasket when it is installed to help in later removal.

2.8 Calibration

For best results, the Sanitary Durafet III Electrode should be calibrated at regular intervals, determined by experience for the particular process. Refer to the instruction manual of the pH Analyzer you are using for calibration procedures.

3. Maintenance

3.1 Shelf Life and Storage

Periodic maintenance is required to ensure that the electrode does not dry out after prolonged shelf storage. Stored electrodes should be checked every 6 months to ensure that the cotton packing is still wet in the storage cap.

For stored electrodes, perform the following procedures every 6 months:

1. Remove the electrode from its storage box and pull the vinyl cap from the sensing end.
2. Remove any excess crystals on the sensor area by rinsing with warm tap water.
3. Refill the cap with water to soak the cotton packing.
4. Replace the cap on the electrode.
5. Place electrode back in its storage box. Mark the date on the box.

NOTICE

Do not store electrode at or below $-10\text{ }^{\circ}\text{C}$ ($+14\text{ }^{\circ}\text{F}$) or above $50\text{ }^{\circ}\text{C}$ ($122\text{ }^{\circ}\text{F}$).

3.2 Cleaning

How often the electrode needs to be removed for cleaning depends on process conditions. Some process materials tend to adhere to the sensor and could interfere with the accuracy or time response of measurements. If it becomes necessary to remove the electrode for cleaning, proceed as follows:

1. Remove the electrode from service and disconnect the cable from the electrode.
2. Place the electrode under flowing warm tap water to remove any loose or lodged debris.
3. Remove oil deposits with a household detergent (Joy or Windex) or a laboratory detergent (Micro or Sparkleen).
4. Clean the electrode body with almost any commercial cleaning agent.

If the reference electrode junction is clogged or dirty, remove the storage cap from the electrode (if necessary) and immerse the end of the electrode for one hour in tap water at approximately $90\text{ }^{\circ}\text{C}$. If this does not fully unclog the reference electrode junction, perform the following:

1. Place the electrode in a beaker of saturated potassium chloride (KCl) solution and heat to boiling.
2. Remove from heat and let the electrode soak in this solution until it cools to room temperature.

3.3 Replacement and Accessory Parts

Replacement and Accessory Parts are listed in Table 3-1. See Table 1-1 for replacement electrode part numbers.

Table 3-1 Replacement and Accessory Parts

Description	Part No.
Replacements:	
Electrode Storage Cap	31086225
1-1/2" Flange Protector	31086266
2" Flange Protector	31086267
3" Flange Protector	31086268
Accessories:	
Standard Buffer Reference Solution (1 Pint)	
4.01 pH	31103001
6.86 pH	31103002
9.18 pH	31103003
Cap Adapter Cables (Direct Connection 9782P or APT2000/4000PH)	
20 foot length	51453388-001
50 foot length	51453388-002
DirectLine Remote Mounting Cable	
20 foot length	51453225-001
50 foot length	51453225-002

Honeywell

Industrial Measurement and Control

Honeywell

1100 Virginia Drive

Fort Washington, PA 19034