

## DT90A Digital Room Thermostat

User Guide / Guía del Usuario / Utilisation / Gebruikershandleiding / Bedienung / Guida per l'Utente / Használati Utasítás / Návod k Použití / Obštuga / Návod na Použitie

- GB Room temperature
- E Indicación de temperatura ambiente
- F Lecture de la température ambiante
- NL Ruimtetemperatuurweergave
- D Raumtemperatur-Istwert
- I Lettura temperatura ambiente
- HU Aktuális helyiség-hőmérséklet
- CZ Aktuální pokojová teplota
- PL Odczyt temperatury
- SK Izbová teplota



50035439-001 B

- GB Set temperature, inquiry
- E Consulta de temperatura deseada
- F Lecture de la température demandée
- NL Uitlezen van de ingestelde temperatuur
- D Eingestellte Temperatur anzeigen
- I Interrogazione temperatura impostata
- HU Beállított hőmérséklet lekérdezése
- CZ Zobrazení žádané teploty
- PL Odczyt temperatury zadanej
- SK Informácia o teplote

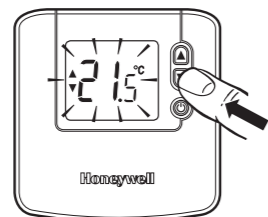

- GB Set temperature, adjustment
- E Ajuste de temperatura deseada
- F Réglage de la température demandée
- NL Wijzigen van de ingestelde temperatuur
- D Eingestellte Temperatur ändern
- I Modifica temperatura impostata
- HU Kívánt hőmérséklet beállítás
- CZ Nastavení žádané teploty
- PL Ustawianie temperatury zadanej
- SK Nastavenie požadovanej teploty

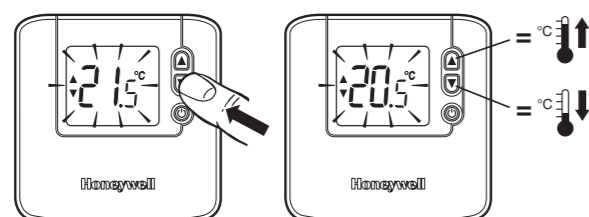

- GB Switch ON/OFF (frost protection enabled)
- E Botón de encendido / apagado (protección antihielo activada)
- F Bouton Marche/Arrêt (avec protection anti-gel)
- NL AAN/UIT-toets (vorstbeveiliging actief)
- D Schalter Ein / Aus (Frostschutz aktivieren)
- I Interruttore ON / OFF (protezione antigelo abilitata)
- HU KI/BE kapcsoló (fagyvédelem aktivizálása)
- CZ Spínač Zapnuto/Vypnuto (aktivovaná protimrazová ochrana)
- PL Włącz/Wyłłącz (aktywna ochrona przeciwzamrazaniowa)
- SK Spínač Zapnutý/Vypnutý (aktivovaná protimrazová ochrana)

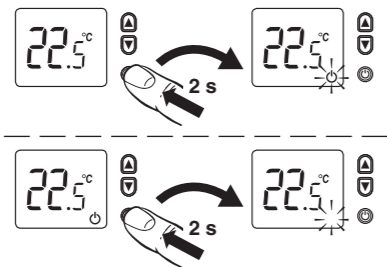

### Operating indicators / Indicadores de funcionamiento / Indicateurs de fonctionnement / Bedrijfsmodussymbolen / Betriebsanzeige / Indicatore di funzionamento / Kezelési útmutató / Stavové symboly / Wskaźniki pracy regulatora / Stavové symboly

- GB Heating demand indicator
- E Indicador de demanda de calefacción
- F Indicateur de demande de chauffage
- NL Warmtevragsymbool
- D Anzeige Heizlastanforderung
- I Indicatore di richiesta riscaldamento
- HU Hőigény jelzés
- CZ Symbol požadavku na sepnutí kotle
- PL Wskaźnik włączonego palnika
- SK Symbol požiadavky na zopnutie kotla

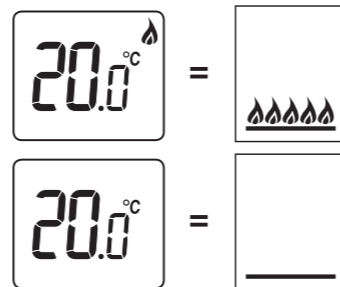

- GB Frost protection
- E Protección antihielo
- F Fonction de protection antigel
- NL Vorstbeveiliging
- D Frostschutz
- I Protezione antigelo
- HU Fagyvédelem
- CZ Protimrazová ochrana
- PL Ochrona przeciwzamrazaniowa
- SK Protimrazová ochrana



Frost protection is not available in cooling operation  
La protección antihielo no está activada en modo refrigeración  
La protection antigel n'est pas active en mode froid  
Vorstbeveiliging is niet beschikbaar in koeling.  
Frostschutz ist im Kühlbetrieb nicht möglich  
La protezione antigelo non è attivata in modalità raffrescamento  
A fagyvédelem nem elérhető hűtési üzemmódban.  
Protimrazová ochrana je v chladičím režimu vypnuta  
Ochrona przeciwzamrazaniowa nie jest aktywna w trybie chłodzenie  
Protimrazová ochrana je v chladiacom režime vypnutá

- GB Fault indicator
- E Indicador de fallo
- F Indicateur de défaut
- NL Storingssymbool
- D Störungsanzeige
- I Indicatore anomalia
- HU Hiba jelzés
- CZ Výskyt poruchy
- PL Usterka
- SK Výskyt poruchy

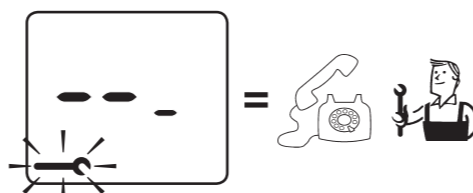

- GB Low battery indicator
- E Indicador de pilas agotadas
- F Indication d'usure de piles
- NL Symbool voor batterijvervanging
- D Anzeige für Batteriewechsel
- I Indicazione cambio delle batterie
- HU Kimerült elem jelzés
- CZ Indikace vybité baterie
- PL Wskaźnik wyładowania baterii
- SK Indikácia vybitých batérii

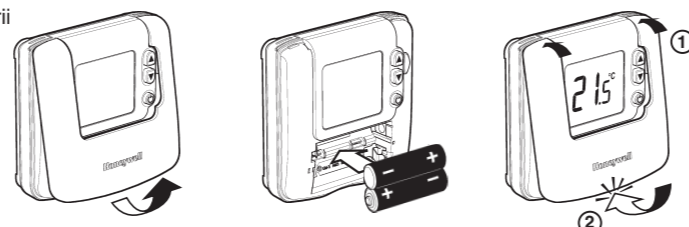
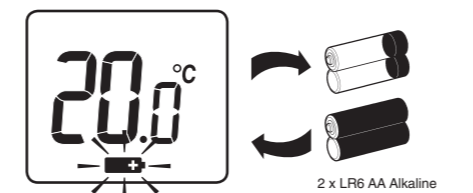

- GB Heat/cool changeover
- E Cambio calefacción/aire acondicionado
- F Chauffage/Réfrigérissement
- NL Overschakeling warmen/koelen
- D Wechsel heizen/kühlen
- I Cambiamento caldo/freddo
- HU Hűtés/fűtés váltás
- CZ Změna topení/chlazení
- PL Zmiana ogrzewania/chłodzenie
- SK Zmena kúrenia a chladenia

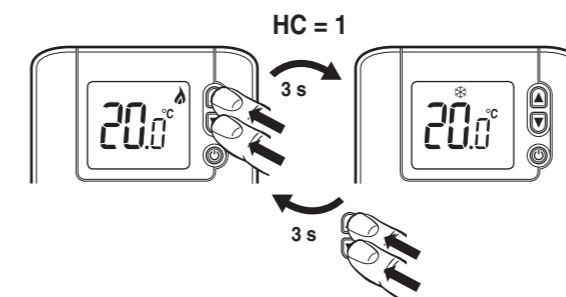

### What is a room thermostat? ...an explanation for householders



A room thermostat simply switches the heating system on and off as necessary. It works by sensing the air temperature, switching on the heating when the air temperature falls below the thermostat setting, and switching it off once this set temperature has been reached. Turning a room thermostat to a higher setting will not make the room heat up any faster. How quickly the room heats up depends on the design of the heating system, for example, the size of boiler and radiators.



Neither does the setting affect how quickly the room cools down. Turning a room thermostat to a lower setting will result in the room being controlled at a lower temperature, and saves energy.

The heating system will not work if a time switch or programmer has switched it off.

The way to set and use your room thermostat is to find the lowest temperature setting that you are comfortable with, and then leave it alone to do its job. The best way to do this is to set the room thermostat to a low temperature – say 18°C – and then turn it up by one degree each day until you are comfortable with the temperature. You won't have to adjust the thermostat further. Any adjustment above this setting will waste energy and cost you more money.

If your heating system is a boiler with radiators, there will usually be only one room thermostat to control the whole house. But you can have different temperatures in individual rooms by installing thermostatic radiator valves (TRVs) on individual radiators. If you don't have TRVs, you should choose a temperature that is reasonable for the whole house. If you do have TRVs, you can choose a slightly higher setting to make sure that even the coldest room is comfortable, then prevent any overheating in other rooms by adjusting the TRVs.

Room thermostats need a free flow of air to sense the temperature, so they must not be covered by curtains or blocked by furniture. Nearby electric fires, televisions, wall or table lamps may prevent the thermostat from working properly.

This product and its associated documentation and packaging are protected by various intellectual property rights belonging to Honeywell Inc and its subsidiaries and existing under the laws of the UK and other countries. These intellectual and property rights may include patent applications, registered designs, unregistered designs, registered trade marks, unregistered trade marks and copyrights. Honeywell reserves the right to modify this document, product and functionality without notice. This document replaces any previously issued instructions and is only applicable to the product(s) described. This product has been designed for applications as described within this document. For use outside of the scope as described herein, refer to Honeywell for guidance. Honeywell cannot be held responsible for misapplication of the product(s) described within this document.

Manufactured for and on behalf of the Environment and Combustion Controls Division of Honeywell Technologies Sàrl, ACS-ECC EMEA, Z.A. La Pièce 16, 1180 Rolle, Switzerland, by its Authorised Representative Honeywell Inc.



## DT90A Digital Room Thermostat

Installation / Instalación / Installasion / Installatie /  
Installazione / Telepítés / Montáž / Instalacja / Inštalácia

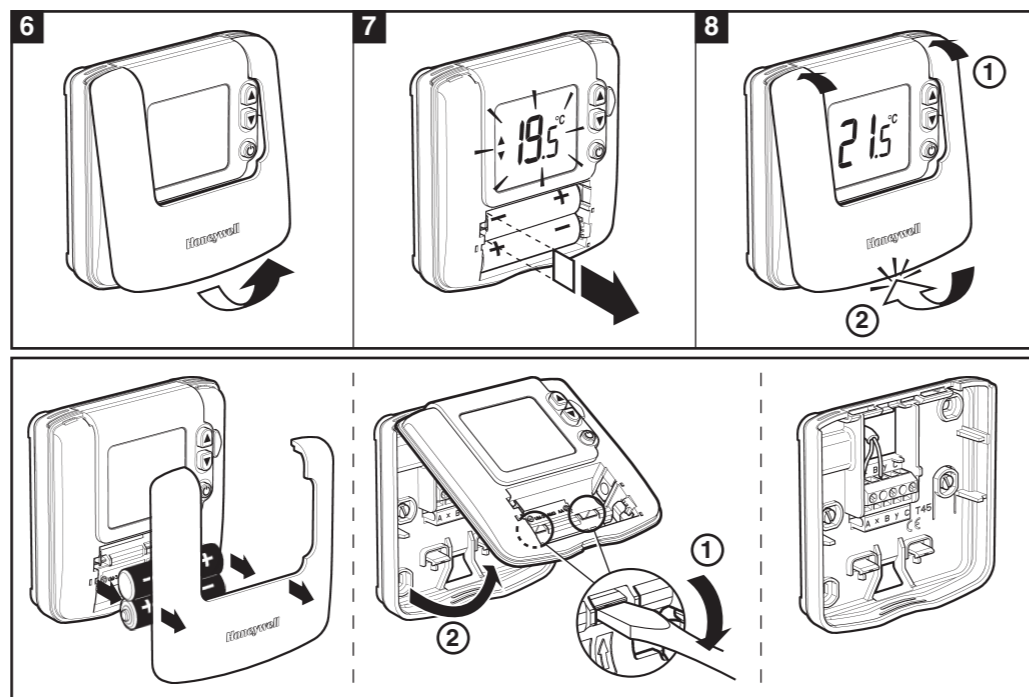
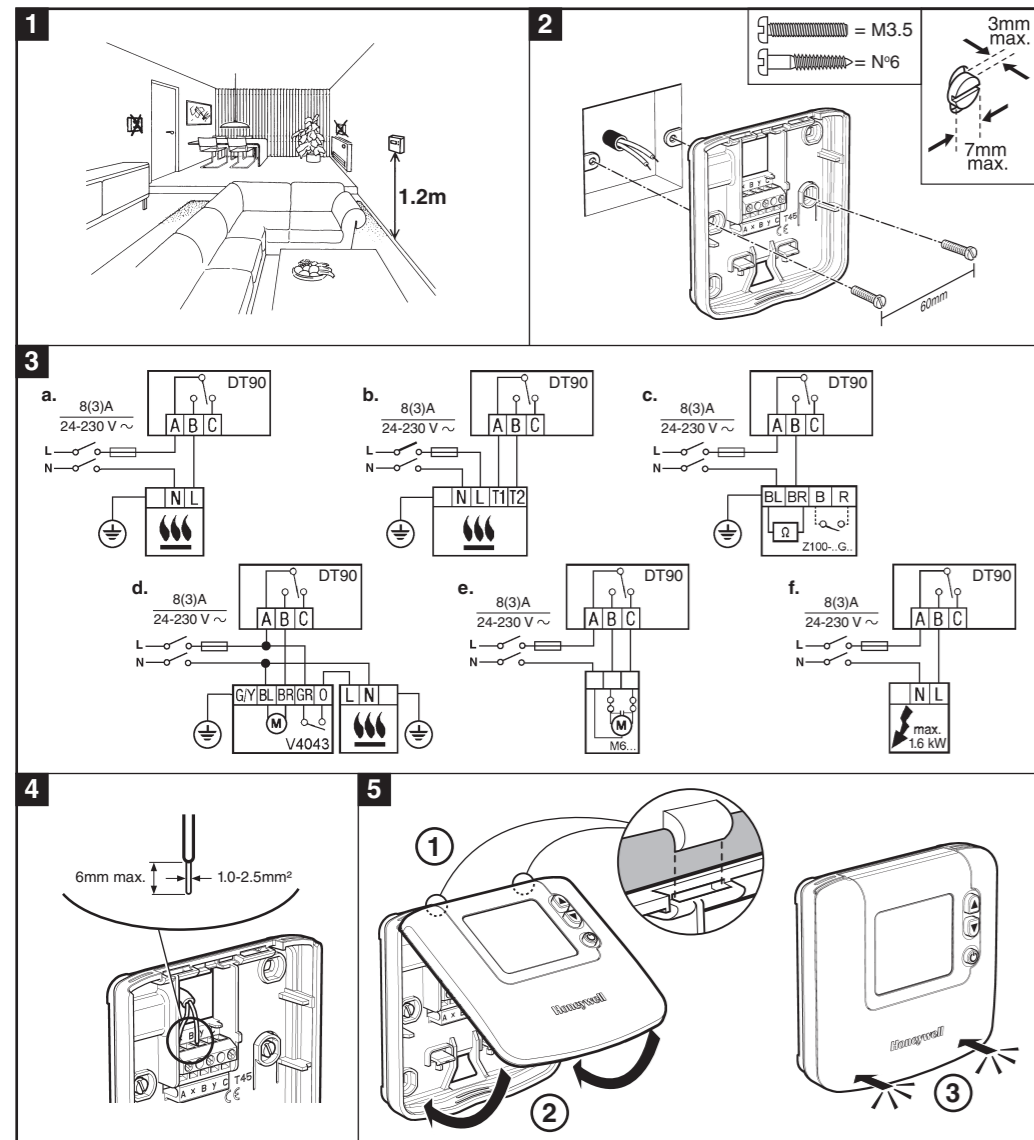

### Installer Mode / Modo de Instalador / Mode Installateur / Installateursmenu / Installateur-Modus / Modalità Installatore / Telepítői üzemmód / Režim nastavení / Tryb instalatora / Režim nastavenia

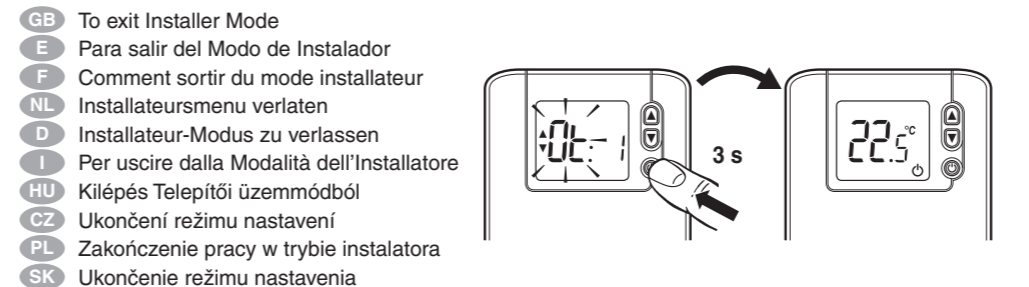
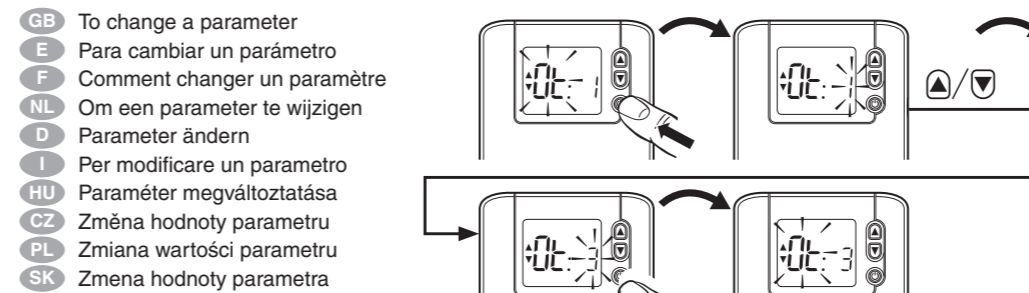
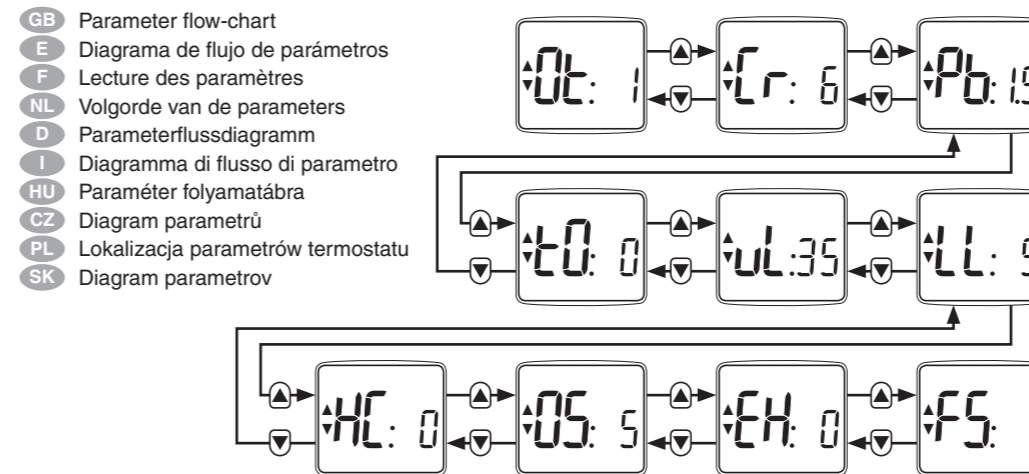
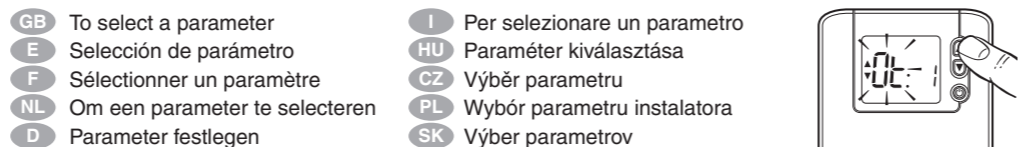
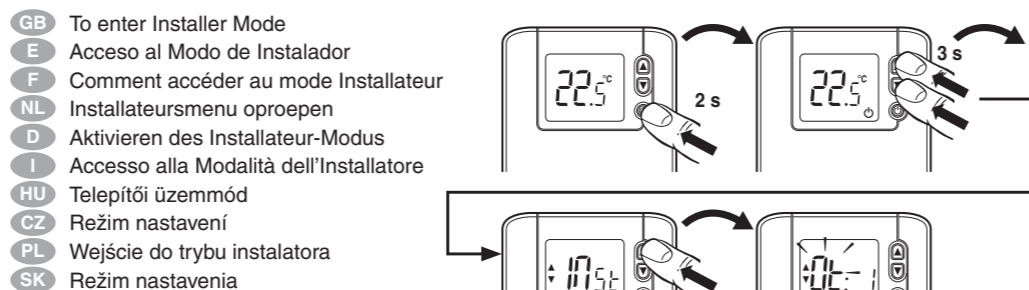

### Parameters / Parámetros / Paramètres / Parameters / Parameter / Parametri / Paraméterek / Parametry / Parametry / Parametre

Description Description Description Omschrijving Beschreibung Descrizione Leírás Popis Opis parametru Popis	Parameter Parámetro Paramètre Parameter Parametro Paraméter Parametr Parametr	Range of values Rango de ajuste Plage de réglage Instelmogelijkheden zusätzliche Einstellungen Campo di modifica Érték tartomány Rozsah hodnot Zakres wartości Rozsah hodnot	Default Predfiniti Valeur d'usine Fabriekinstelling Werkzeinstellungen Predfiniti Alapbeállítás Přednastavené hodnoty Ustawienie fabryczne Prednastavené hodnoty
Minimum ON/OFF time / Tiempo mínimo de marcha / Durée minimale de marche/arrêt / Minimale aan/uit tijd / Minimale Einschaltzeit Ein/Aus / Tempo minimo accesso/spento / Minimum BE/KI idő / Minimální doba seprnutí / Minimalny czas załączenia kotta / Minimalna doba zopnutia	Ot	1,2,3,4,5 m	1 m
Cycle rate / Frecuencia de los ciclos / Nombre de cycles/heure / Aantal schakelingen per uur / Zykluszeit / Frequenza dei cicli / Ciklusidő / Počet cyklů / Częstotliwość cykli / Počet cyklov	Cr	{3,6,9,12}	6
Proportional band width / Amplitud de banda proporcional / Bande proportionnelle / Proportionale bandbreedte / Proportionalband / Larghezza della banda proporzionale / Arányos sáv szélesség / Sírka pásma proporcionalità / Szerokość pasma proporcjonalnego / Sírka pásma proporcionalità	Pb	1.5 ... 3.0 K	1.5K
Temperature measurement offset / Desviación permanente de la temperatura / Etalonnage de la sonde / Temperatuurcompensatie / Temperatur-Offset / Compensazione della temperatura / Hőmérséklet mérés eltolás / Korekce naměřené teploty / Kompensacja temperatury / Korekcia nameranej hodnoty	tO	-3 ... 3 K	0 K
Upper setpoint limit / Limite superior de temperatura / Température limite de consigne maximale / Max. temp. instelling / Obere Temperatursollwertgrenze / Limite superiore della temperatura / Felső alajel korlát / Nejvyšší nastavitelná teplota / Górný limit teploty / Najvyššia nastaviteľná teplota	uL	21 ... 35 °C	35°C
Lower setpoint limit / Limite inferior de temperatura / Température limite de consigne minimale / Min. temp. instelling / Untere Temperatursollwertgrenze / Limite inferiore della temperatura / Alsó alajel korlát / Nejnižší nastavitelná teplota / Dolny limit teploty / Najnižšia nameraná teplota	LL	5 ... 21 °C	5°C
Heat/cool changeover / Cambio calefacción/aire acondicionado / Chauffage/Réfrigérissement / Overschakeling warmen/koelen / Wechsel heizen/kühlen / Cambiamento caldo/freddo / Hűtés/fűtés váltás / Změna topení/chlazení / Zmiana ogrzewanie/chłodzenie / Zmena kúrenia a chladenia	HC	0, 1 0 = Disable / Desactivado / Désactivée / Uitgeschakeld / Aus / Disattivato / Letitva / Deaktivováno / Wyłączony / Vypnuté 1 = Enable / Activado / Activée / Ingeschakeld / Ein / Attivat / Engedélyezve / Aktivováno / Włączony / Zapnuté	0
Off setpoint adjust / Temperatura de consigna modo Paro / Point de consigne anti-gel / Ingestelde temperatuur bij UIT / Frostschutztemperatur aus / Punto di regolazione spento / Fagyvédelmi alajel beállítás / Nastavení protimrazové ochrany / Temperatura utrzymywana gdy thermostat jest wyłączony / Nastavenie protimrazovej ochrany	OS	-- (= Off), 5...16°C	5°C
Electric heat / Calefacción eléctrica / Chauffage électrique / Elektrische verwarming / Elektrische Heizung / Riscaldamento elettrico / Elektromos fűtés / Elektrické vytápění / Ogrzewanie elektryczne / Elektrické vykurovanie	EH	0 (<3A) / 1 (3A – 8A)	0 (<3A)
Reset parameters / Reseteo de los parámetros / Réinitialisation des paramètres / Parameters terug zetten naar fabriekinstellingen / Parameter rücksetzen / Reset parametri / Paraméter nullázás / Reset všech parametrů / Powrót do ustawień fabrycznych / Reset všetkých parametrov	FS	0 / 1	1 (factory)

