

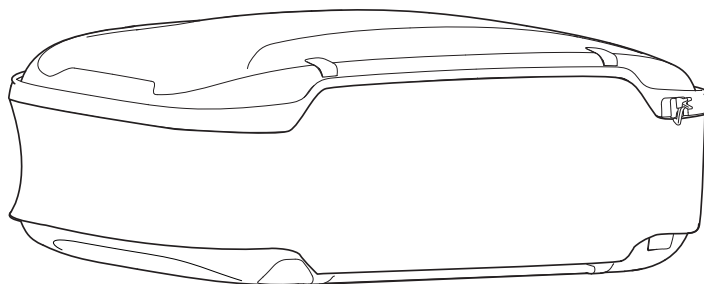

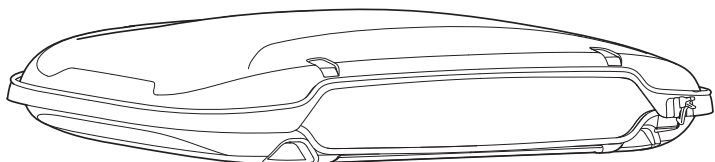

INSTALLATION AND SAFETY INSTRUCTIONS
INSTRUCTIONS POUR L'INSTALLATION ET LA SÉCURITÉ
EINBAU-UND SICHERHEITSHINWEISE
MONTERING- OCH SÄKERHETSINSTRUKTIONER

autoform
URBAN LOADER

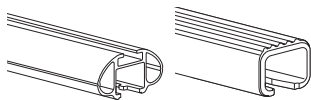

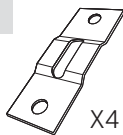
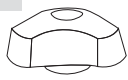
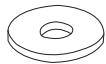
A  X2	B  X4	C  X8	D  X8	
E  X4	F  X4	G  X4	H  Place this label on the side of the bin.	I  X2

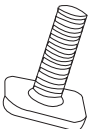
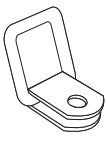
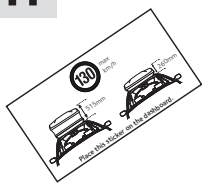
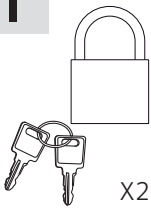
INSTALLING

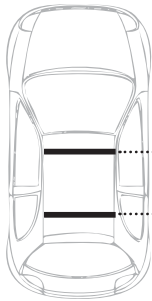
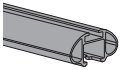
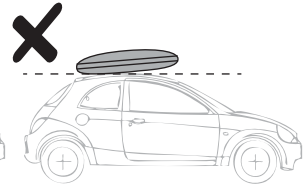
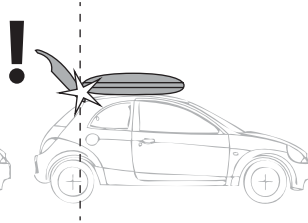
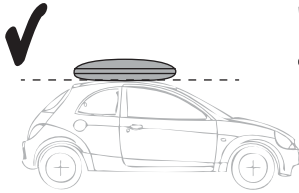
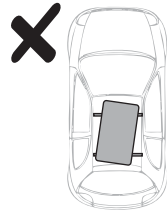

min 395 mm
max 810 mm

- C
- D
- G
- B
- F

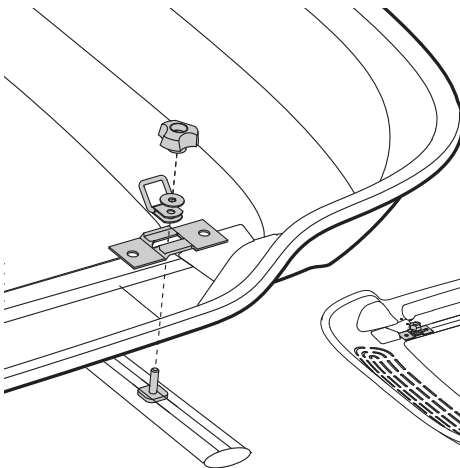

Attach the box to the roof racks on all four attachment points

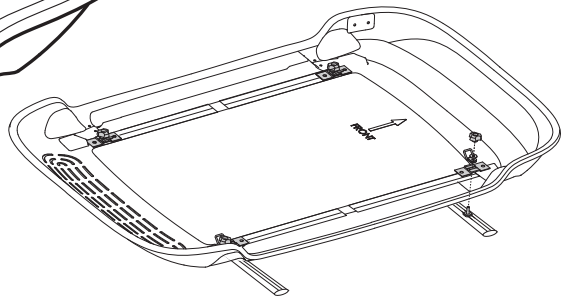

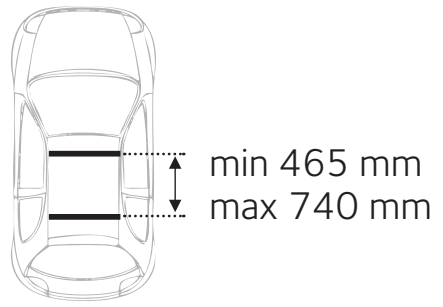
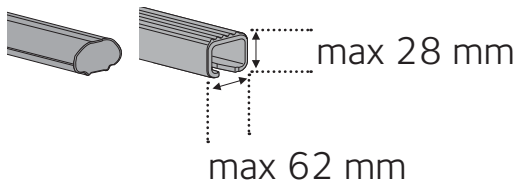

Attach the box to the roof racks on all four attachment points

- C
- D
- G
- B
- E

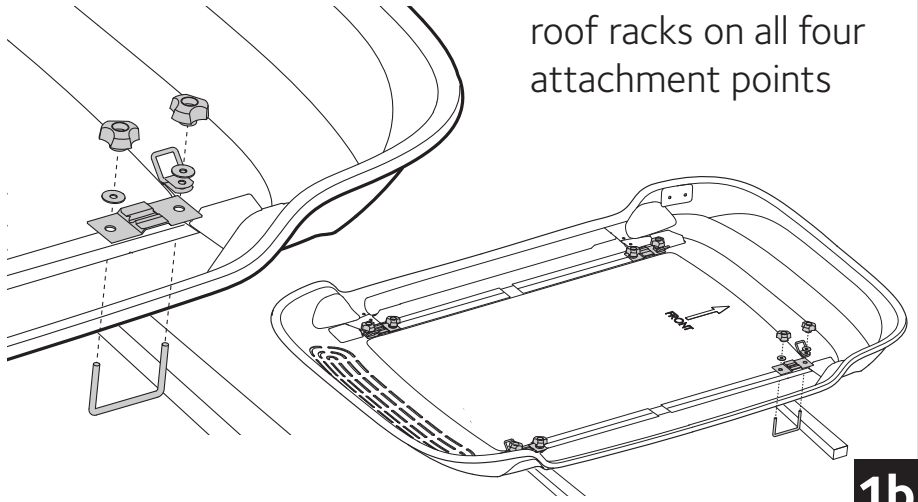

A

Attach loading straps

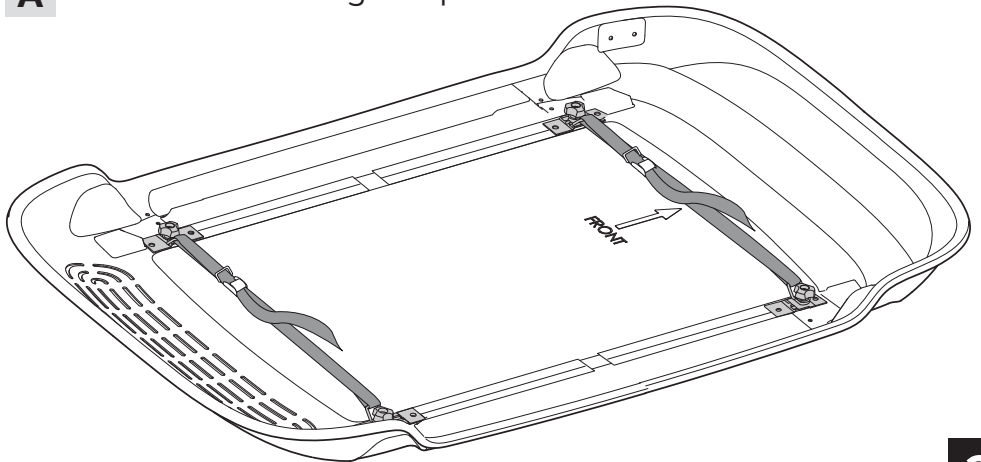

OPENING

- 1) Open outer zipper completely
- 2) Release the hitch and push the top upwards.

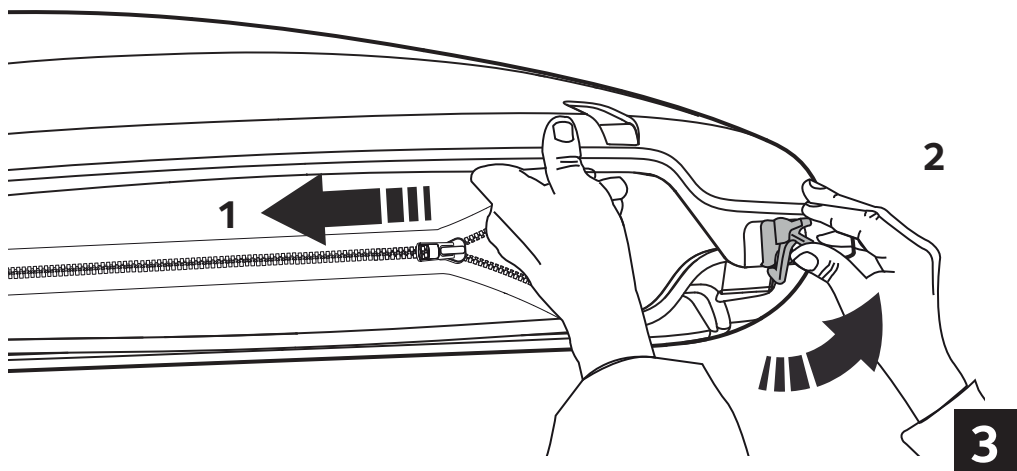

- 1) Push until top clicks into place. Repeat on other side.
- 2) Open the inner zipper.

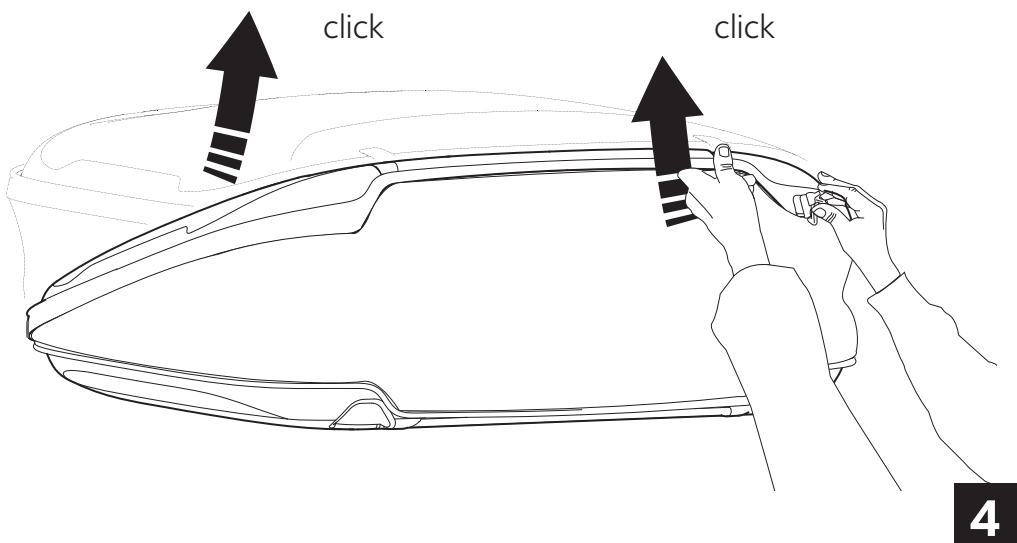

LOADING

Place the load evenly throughout the box.
All items are to be fastened with the loading straps.

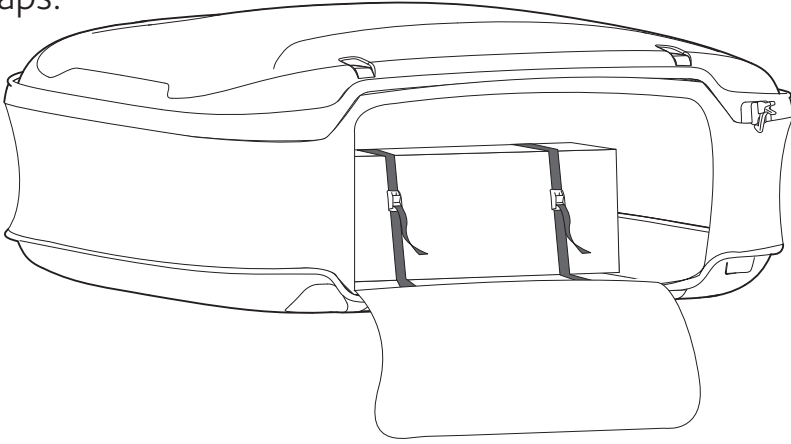

5

Warning!

Load must not contain any sharp objects.
Do not close top when loaded.
Max load: 50kg

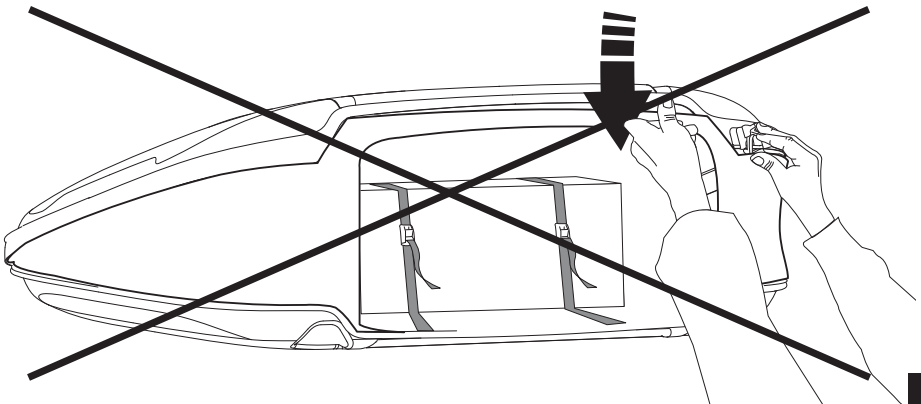

6

CLOSING

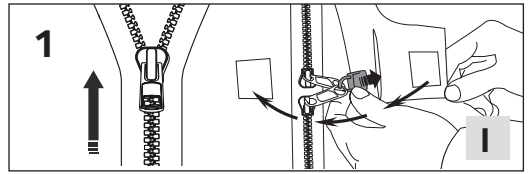

- 1) Close inner zipper and secure with padlocks.
- 2) Push to close.
- 3) Use both hands when closing.

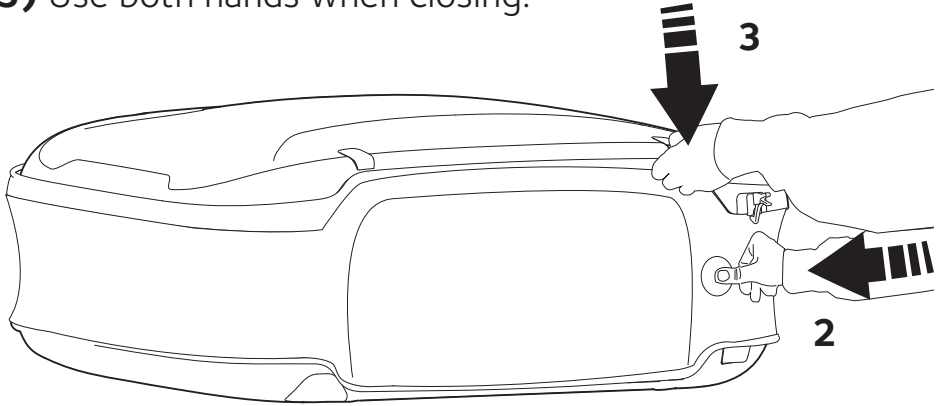

7

Box is properly closed when top covers bottom and both hitches are clicked into place and outer zipper is closed.

click

click

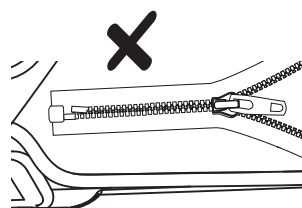
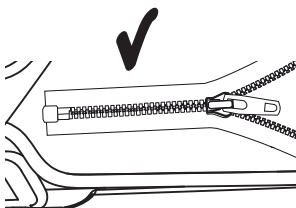
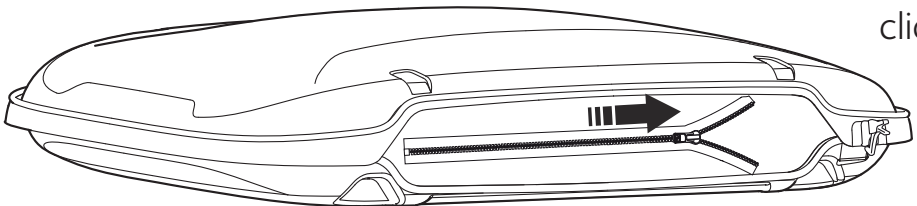

Make sure that the two ends are completely drawn together.

8

Check drivers manual for maximum permitted roof load of your car.

15 kg

+ 50 kg

< max



The roof box is water resistant, not completely water proof.



Warning!

130 max km/h

H

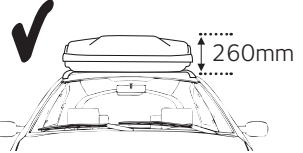
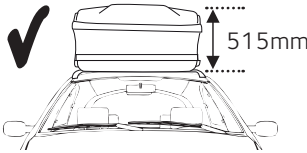
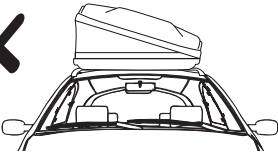

Place the attached sticker on the dashboard.

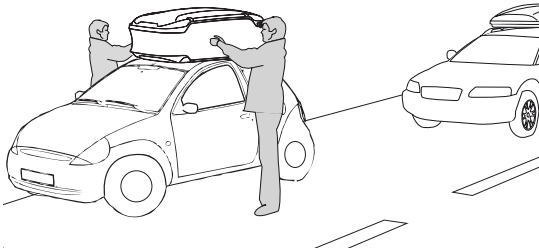

Please consider difference in car behavior (crosswinds, cornering and braking)

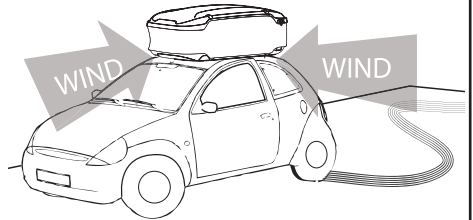

H₂O

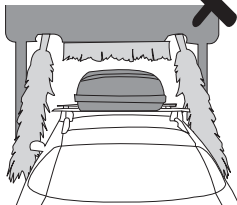
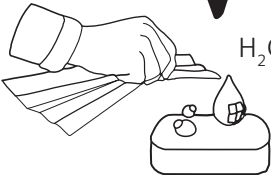

x 4/year

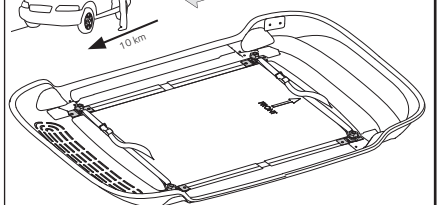

UL-05

autoform

Autoform AB
Box 155
782 24, Malung
SWEDEN

Phone: +46(0)280-59 33 00

E-mail: info@autoform.se

For energy saving and safety reasons,
remove roof box and roof racks when not in use.