

Design by Nahtrang Design

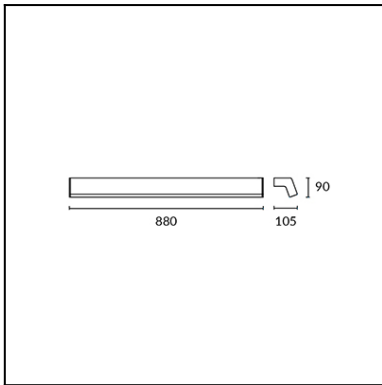

L'acabat de la fotografia pot no coincidir amb el de la referència. Per identificar el real veure descripció de l'acabat



Descargar formato .ldt /.ies

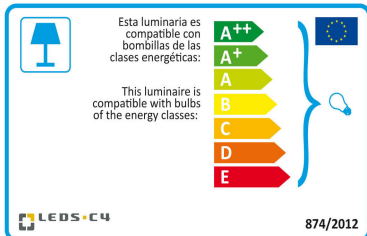

Cliqueu sobre la imatge per descarregar l'etiqueta energètica

CARACTERÍSTIQUES TÈCNiques

Tipus:	APLIC
Índex protecció IP:	IP44
Font de llum 1:	2 x G5
Làmpara especificada a l'etiquetatge de la lluminària	21W
Angle Òptiques / Reflector:	
Voltatge / Freqüència:	220-240V/50-60Hz
Garantia:	2
Unitats per caixa:	8
Pes net (Kg):	1.555
Codi EAN:	8435111089866



MATERIALS / ACABATS

Material estructura: Alumini extrusionat

Material difusor: Policarbonat

Acabat estructura: Crom

Acabat difusor: Opal mate

EQUIP

Equip inclòs: Si, electrònic

Luminaire		Measur.		Lamp		
Code	05-4700-21-M1	Code	05-4699-21-M1	Code	TL5 HE sup80 21W/840	
Name	Aplique CONCEPT 2x21W T5	Name	Aplique 2x14W T5 dif. acritico	Number	2	
Line	- LEDS-C4	Date	25-06-2013	Position	Universal	
Efficiency	41.55%	Coordinate system	CG	Total Flux	4200.00 lm	
Maximum value	325.30 cd	Position	C=0.00 G=0.00	Sym. on planes 270-90		
Rectangular Luminaire	Length	90 mm	Width	880 mm	Height	105 mm
Rectangular Luminous Area	Length	70 mm	Width	870 mm	Height	45 mm
Horizontal Luminous Area	0.060900 m2	Emitting area on Plane 180°		0.003150 m2		
Emitting area on Plane 0°	0.003150 m2	Emitting area on Plane 270°		0.039150 m2		
Emitting area on Plane 90°	0.039150 m2	Glare area at 76°		0.017789 m2		
Symmetry Type	Sym. on planes 270-90	Maximum Gamma Angle		180		
Measurement Distance	6.44	Measurement Flux		2400.00 lm		
Operator	Asselum T2	Source voltage		230.00 V		
Temperature	23.00 °C	Source current		PRC		
Humidity	54.00 %	Photocell				
Notes						

Luminaire Lamps						
Line	Code	Name	Flux [lm]	Pow. [W]	Q.ty	
PHILIPS 2005 ILCOS FD,FC	TL5 HE sup80 21W/840	MASTER TL5 HE super80 21W/840	2100.00	21.00	2	
C.I.E.	37 65 85 70 42	D DIN 5040	B21			
F UTE	0.29 H + 0.13 T	B NBN	BZ 6			

90mm x 880mm

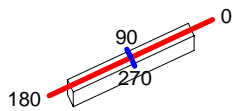

C Halfplanes
 270.0 — Blue
 180.0 — Red
 90.0 — Blue

ULOR 12.56 %
 DLOR 28.99 %
 RN 30.23 %

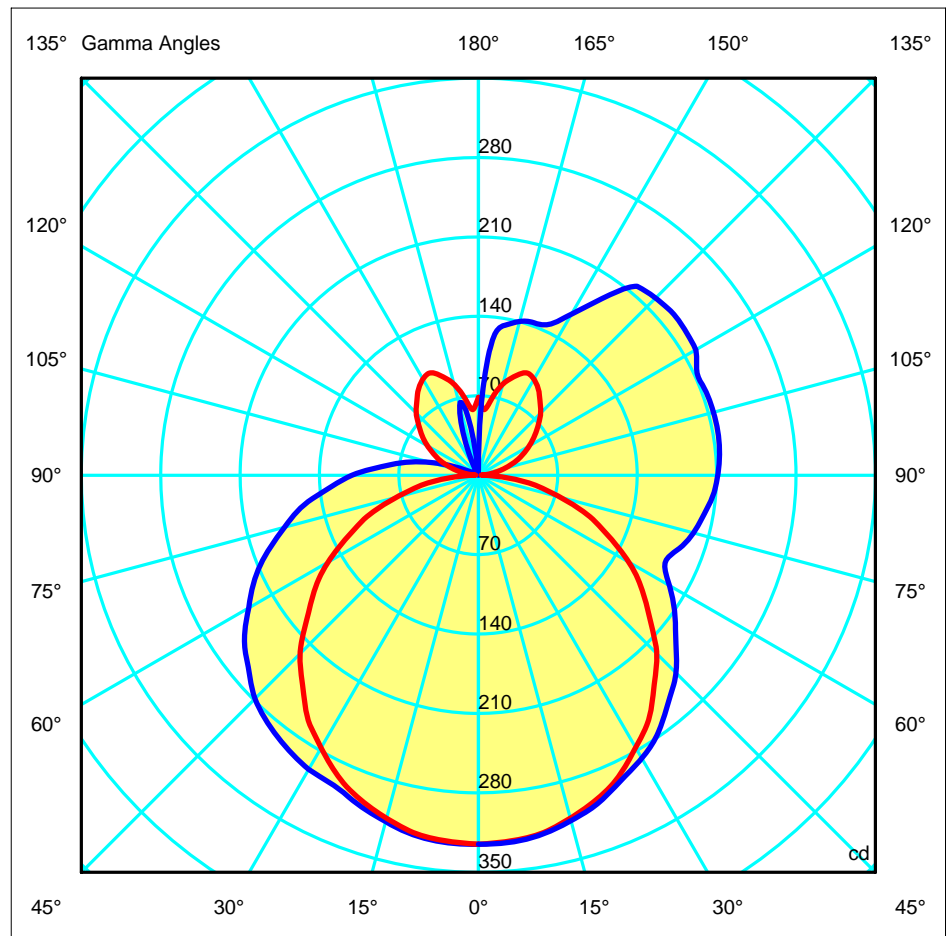

Luminaire	Code 05-4700-21-M1	Measur.	Code 05-4699-21-M1	Lamp	Code TL5 HE sup80 21W/840
Name	Aplique CONCEPT 2x21W T5	Name	Aplique 2x14W T5 dif. acritico	Number	2
Line	- LEDS-C4	Date	25-06-2013	Position	Universal

Efficiency	41.55%	Coordinate system	CG	Total Flux	4200.00 lm
-------------------	--------	--------------------------	----	-------------------	------------

	Luminous Intensity Table cd												Table 1/1
	C 270.00	C 285.00	C 300.00	C 315.00	C 330.00	C 345.00	C 0.00	C 15.00	C 30.00	C 45.00	C 60.00	C 75.00	C 90.00
G 0.0	325.30	325.30	325.30	325.30	325.30	325.30	325.30	325.30	325.30	325.30	325.30	325.30	325.30
G 5.0	324.97	324.91	324.52	324.71	323.52	324.81	323.60	323.22	324.36	323.09	324.63	323.63	324.73
G 10.0	322.39	323.24	320.98	322.08	319.31	321.46	320.55	318.52	320.95	318.24	320.75	319.07	321.60
G 15.0	315.96	318.74	315.43	317.16	312.22	314.39	312.91	309.90	314.09	311.58	315.35	312.21	315.21
G 20.0	309.06	311.68	306.04	308.29	302.41	306.16	304.25	300.22	305.19	300.77	306.09	303.47	307.87
G 25.0	301.53	303.13	296.67	298.87	289.92	292.96	292.78	285.57	293.48	290.20	296.79	294.10	297.02
G 30.0	299.30	297.65	288.55	286.25	276.39	279.90	277.22	271.21	279.91	276.47	285.16	283.16	288.11
G 35.0	293.88	293.59	282.85	272.52	259.55	265.58	262.05	253.01	263.21	261.27	271.68	268.95	276.59
G 40.0	287.18	287.02	274.44	263.76	241.52	244.93	241.08	234.03	245.85	244.92	257.71	253.21	260.67
G 45.0	278.56	279.00	262.95	251.45	224.96	226.31	222.30	214.64	228.43	225.24	238.89	236.54	246.33
G 50.0	264.70	267.60	250.99	239.25	208.84	202.04	197.42	190.14	207.86	206.74	222.14	218.79	227.23
G 55.0	251.76	253.72	234.43	223.65	193.33	180.69	176.28	168.91	185.86	184.06	200.92	200.85	211.30
G 60.0	233.82	238.23	218.66	206.32	174.81	156.90	153.09	141.99	162.88	164.03	183.08	183.35	194.36
G 65.0	217.71	220.35	199.19	188.44	154.79	134.73	126.28	119.44	139.20	142.26	165.17	177.96	181.75
G 70.0	197.93	201.43	180.23	168.39	134.19	116.24	102.96	95.75	116.57	127.82	158.98	185.55	188.49
G 75.0	176.81	183.30	160.30	149.58	113.18	92.77	74.21	69.20	92.94	131.60	164.44	191.83	196.28
G 80.0	157.39	161.80	137.28	125.97	91.68	73.45	51.04	47.53	87.96	135.86	169.89	197.35	201.69
G 85.0	132.45	139.62	117.32	106.69	70.38	50.37	25.66	43.06	90.47	139.27	174.10	201.83	207.54
G 90.0	111.50	116.93	92.64	85.06	51.27	32.21	3.97	45.75	93.57	142.86	178.30	205.11	210.97
G 95.0	86.05	93.91	71.94	63.06	30.67	14.73	6.23	50.62	96.82	145.33	180.71	207.24	213.38
G100.0	65.59	70.75	49.17	42.42	10.52	2.30	15.90	59.43	100.13	147.75	182.36	208.17	214.57
G105.0	43.51	49.06	28.31	21.21	2.45	3.24	23.96	67.15	105.60	150.24	183.59	208.14	214.53
G110.0	21.22	28.59	9.67	4.64	2.55	4.55	34.38	67.09	116.41	158.95	184.16	207.51	213.95
G115.0	4.31	7.94	2.46	2.33	2.89	5.52	42.84	66.67	124.27	167.38	190.52	212.51	212.73
G120.0	2.15	2.47	2.28	2.42	3.16	8.79	51.80	75.09	130.41	172.27	196.07	217.35	221.32
G125.0	2.15	2.17	2.35	2.54	3.44	17.17	60.71	83.01	126.82	175.92	200.20	219.64	222.64
G130.0	2.15	2.22	2.42	2.66	3.69	25.01	68.53	91.77	116.50	173.39	202.18	220.36	223.14
G135.0	2.23	2.30	2.50	2.80	7.36	34.51	77.59	99.12	110.96	155.48	200.64	216.31	221.11
G140.0	2.23	2.30	2.57	2.95	20.28	41.09	84.55	105.13	114.48	139.18	185.07	201.38	217.52
G145.0	2.30	2.37	2.64	3.05	33.25	48.35	92.28	111.43	119.49	133.59	162.90	172.35	190.06
G150.0	2.30	2.41	8.97	16.81	45.49	53.54	97.79	115.63	123.69	135.54	142.47	150.19	163.85
G155.0	16.41	8.38	27.03	32.94	52.57	57.47	99.56	114.30	126.65	136.52	140.60	145.31	146.61
G160.0	37.60	30.08	48.02	48.26	51.77	61.72	92.53	103.82	127.63	136.30	139.70	143.02	143.11
G165.0	64.33	51.65	52.98	48.16	54.88	64.81	83.13	91.95	113.40	120.96	137.53	139.52	140.38
G170.0	51.55	60.41	46.37	49.82	55.82	63.24	68.96	71.14	83.40	79.95	123.14	128.75	134.15
G175.0	4.90	30.04	30.85	45.09	55.04	56.56	58.03	62.95	64.13	64.91	65.16	66.08	109.71
G180.0	5.16	8.51	32.71	54.82	65.31	69.07	68.70	69.07	65.31	54.82	32.71	8.51	5.16

Luminaire		Measuram.		Lamp	
Code	05-4700-21-M1	Code	05-4699-21-M1	Code	TL5 HE sup80 21W/840
Name	Aplique CONCEPT 2x21W T5	Name	Aplique 2x14W T5 dif. acritico	Number	2
Line	- LEDS-C4	Date	25-06-2013	Position	Universal
Efficiency	41.55%	Coordinate system	CG	Total Flux	4200.00 lm

90mm x 880mm

C Halfplanes

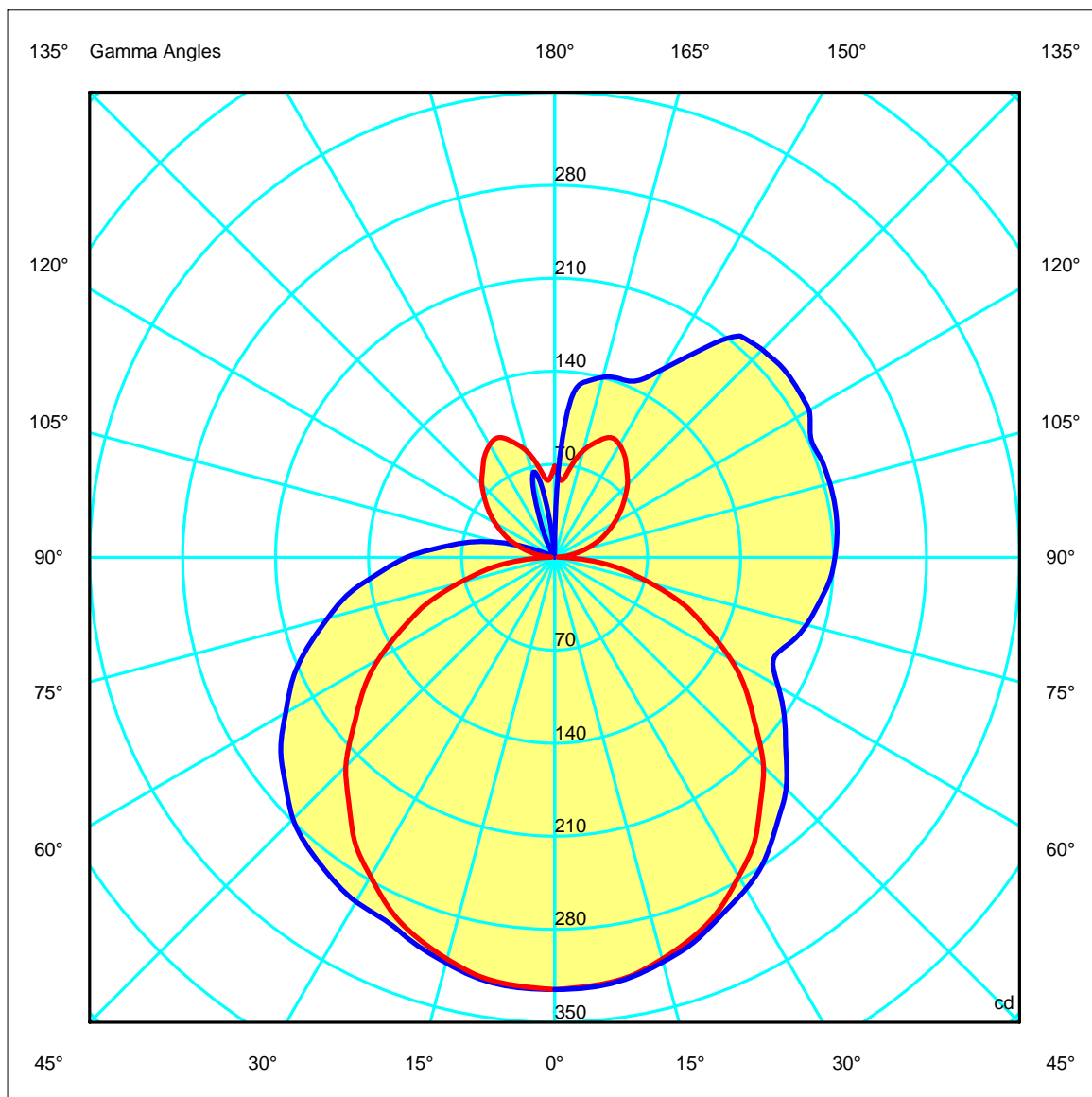
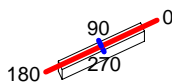
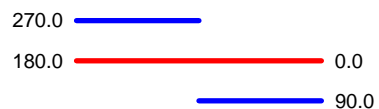

Luminaire		Measur.		Lamp	
Code	05-4700-21-M1	Code	05-4699-21-M1	Code	TL5 HE sup80 21W/840
Name	Aplique CONCEPT 2x21W T5	Name	Aplique 2x14W T5 dif. acritico	Number	2
Line	- LEDS-C4	Date	25-06-2013	Position	Universal
Efficiency	41.55%	Coordinate system	CG	Total Flux	4200.00 lm

90mm x 880mm

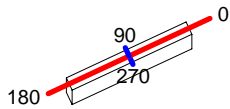

C Halfplanes
 270.0 ————
 180.0 ———— 0.0
 ———— 90.0

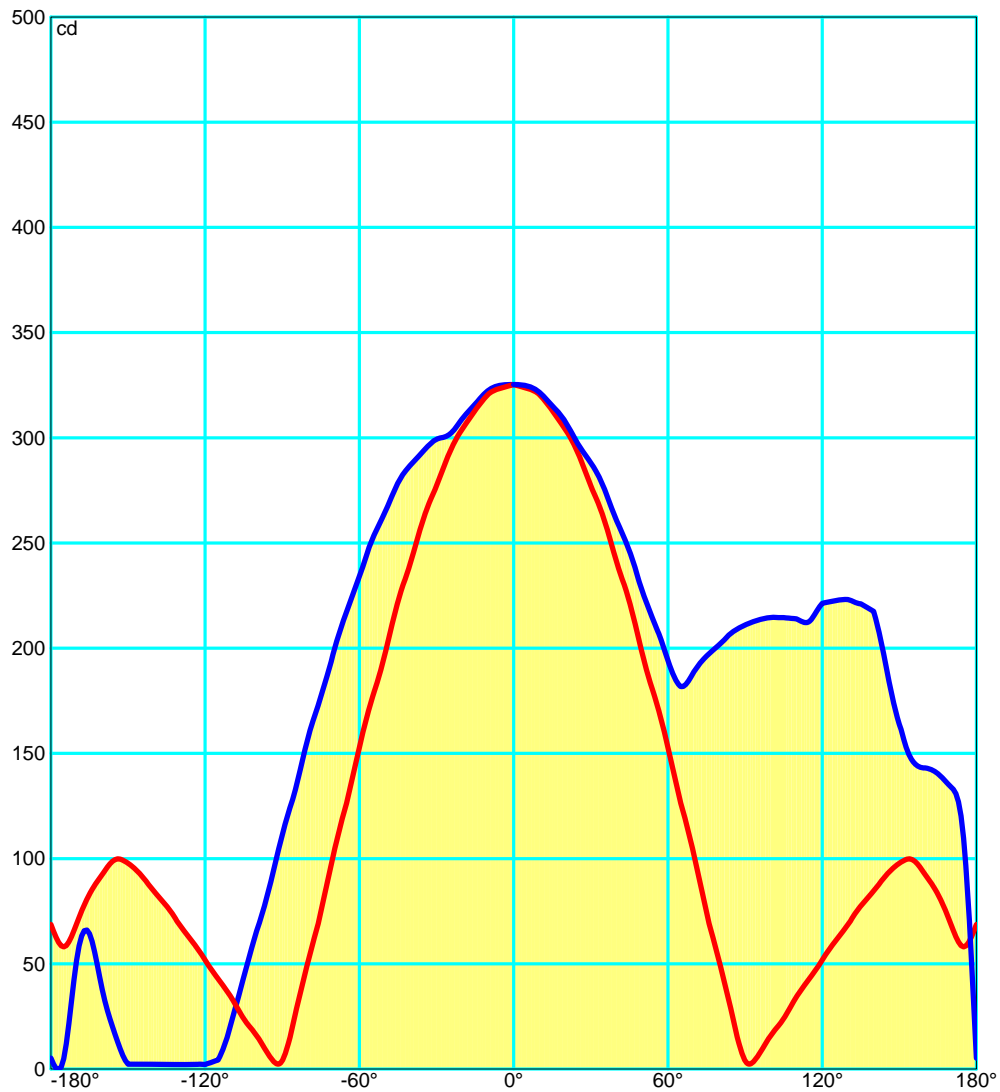

Luminaire		Measur.		Lamp	
Code	05-4700-21-M1	Code	05-4699-21-M1	Code	TL5 HE sup80 21W/840
Name	Aplique CONCEPT 2x21W T5	Name	Aplique 2x14W T5 dif. acritico	Number	2
Line	- LEDS-C4	Date	25-06-2013	Position	Universal
Efficiency	41.55%	Coordinate system	CG	Total Flux	4200.00 lm

UGR
S = 0.250

Reflectancies										
Ceiling/Cavity	0.7	0.7	0.5	0.5	0.3	0.7	0.7	0.5	0.5	0.3
Walls	0.5	0.3	0.5	0.3	0.3	0.5	0.3	0.5	0.3	0.3
WorkingPlane	0.2	0.2	0.2	0.2	0.2	0.2	0.2	0.2	0.2	0.2
RoomDimensions	ViewedCrosswise					ViewedEndwise				
x=2H y=2H	14.5	15.6	15.2	16.3	18.2	15.6	16.7	16.3	17.4	18.2
x=2H y=3H	16.2	17.2	17.0	17.9	20.3	17.8	18.8	18.5	19.5	20.3
x=2H y=4H	16.9	17.9	17.7	18.6	21.4	18.8	19.8	19.6	20.5	21.4
x=2H y=6H	17.5	18.4	18.2	19.1	22.3	19.8	20.7	20.6	21.4	22.3
x=2H y=8H	17.7	18.5	18.5	19.3	22.8	20.3	21.1	21.0	21.9	22.8
x=2H y=12H	17.9	18.6	18.6	19.4	23.1	20.7	21.4	21.4	22.2	23.1
x=4H y=2H	15.3	16.3	16.1	17.0	18.9	16.3	17.2	17.1	18.0	18.9
x=4H y=3H	17.2	17.9	17.9	18.7	21.1	18.6	19.4	19.4	20.2	21.1
x=4H y=4H	18.0	18.7	18.7	19.5	22.3	19.8	20.5	20.6	21.3	22.3
x=4H y=6H	18.6	19.3	19.5	20.1	23.4	21.0	21.6	21.8	22.5	23.4
x=4H y=8H	18.9	19.5	19.8	20.3	24.0	21.6	22.1	22.4	22.9	24.0
x=4H y=12H	19.1	19.7	20.0	20.5	24.5	22.1	22.6	22.9	23.4	24.5
x=8H y=4H	18.6	19.2	19.4	20.0	22.6	20.2	20.8	21.0	21.6	22.6
x=8H y=6H	19.5	20.0	20.4	20.8	23.9	21.5	22.0	22.4	22.9	23.9
x=8H y=8H	19.9	20.3	20.8	21.2	24.6	22.2	22.7	23.1	23.5	24.6
x=8H y=12H	20.2	20.6	21.1	21.5	25.3	22.9	23.3	23.8	24.2	25.3
x=12H y=4H	18.8	19.3	19.6	20.1	22.6	20.2	20.7	21.1	21.6	22.6
x=12H y=6H	19.8	20.2	20.7	21.1	24.0	21.6	22.1	22.5	22.9	24.0
x=12H y=8H	20.3	20.7	21.2	21.6	24.7	22.4	22.8	23.3	23.7	24.7

Luminaire		Measur.		Lamp	
Code	05-4700-21-M1	Code	05-4699-21-M1	Code	TL5 HE sup80 21W/840
Name	Aplique CONCEPT 2x21W T5	Name	Aplique 2x14W T5 dif. acritico	Number	2
Line	- LEDS-C4	Date	25-06-2013	Position	Universal
Efficiency	41.55%	Coordinate system	CG	Total Flux	4200.00 lm

Total Flux=4200.00 Luminaire Flux=1745.19

RI	0.60	0.80	1.00	1.25	1.50	2.00	2.50	3.00	4.00	5.00	10.00	20.00
DRR	0.24	0.31	0.37	0.44	0.49	0.57	0.63	0.67	0.73	0.77	0.86	0.92
RC	7	7	7	7	7	7	7	7	7	7	7	7

Zonal Flux per 1000 Lumen

Y°	10	20	30	40	50	60	70	80	90	100	110	120	130	140	150	160	170	180
ZF(Y)	7	28	61	101	145	188	227	261	290	314	335	353	371	387	399	408	414	416

CIE Flux Codes

37 65 85 70 42

C.I.E.	7	LOR	41.55222 %
D DIN 5040	B21	ULOR	12.56268 %
F UTE	0.29 H + 0.13 T	DLOR	28.98955 %
B NBN	BZ 6	UFF	30.23346 %
RN	30.23346 %	DFF	69.76654 %
BLF	1.0	FFR	43.33520 %

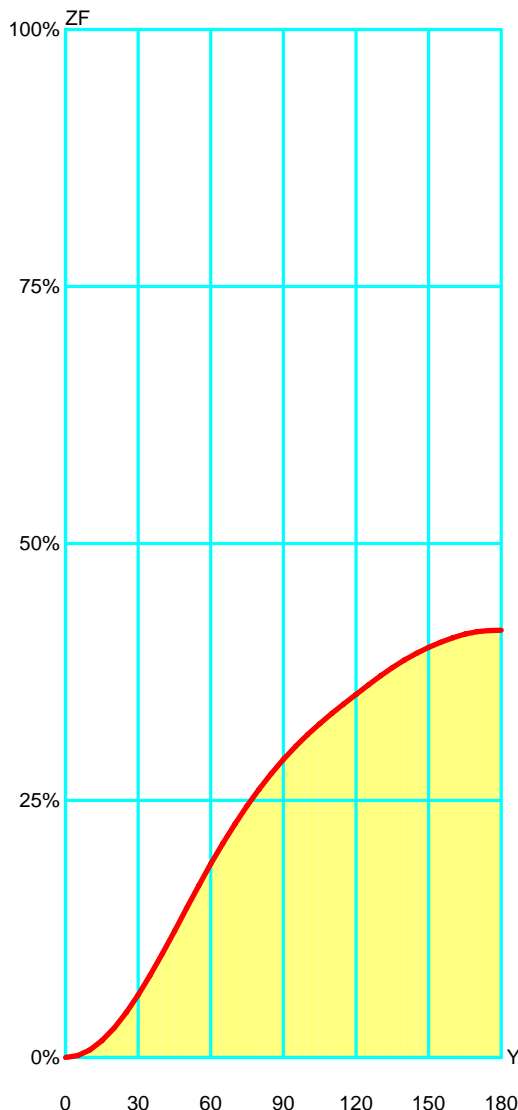

Zonal Flux				
Gamma °	Flux	Sum lm	Flux [%]	Sum [%]
0°	0.00	0.00	0.00%	0.00%
5°	1.85	1.85	0.44%	0.44%
10°	5.49	7.34	1.32%	1.77%
15°	8.96	16.30	2.16%	3.92%
20°	12.15	28.46	2.92%	6.85%
25°	14.98	43.43	3.60%	10.45%
30°	17.40	60.83	4.19%	14.64%
35°	19.39	80.22	4.67%	19.31%
40°	20.86	101.08	5.02%	24.33%
45°	21.81	122.89	5.25%	29.57%
50°	22.17	145.06	5.34%	34.91%
55°	21.97	167.03	5.29%	40.20%
60°	21.24	188.27	5.11%	45.31%
65°	20.09	208.36	4.83%	50.14%
70°	18.83	227.20	4.53%	54.68%
75°	17.59	244.78	4.23%	58.91%
80°	16.29	261.08	3.92%	62.83%
85°	15.03	276.11	3.62%	66.45%
90°	13.79	289.90	3.32%	69.77%
95°	12.60	302.50	3.03%	72.80%
100°	11.54	314.04	2.78%	75.58%
105°	10.62	324.66	2.56%	78.13%
110°	9.90	334.55	2.38%	80.51%
115°	9.39	343.95	2.26%	82.77%
120°	9.20	353.15	2.21%	84.99%
125°	9.08	362.23	2.19%	87.18%
130°	8.75	370.98	2.11%	89.28%
135°	8.19	379.17	1.97%	91.25%
140°	7.46	386.63	1.79%	93.05%
145°	6.58	393.20	1.58%	94.63%
150°	5.71	398.91	1.37%	96.00%
155°	5.02	403.93	1.21%	97.21%
160°	4.36	408.29	1.05%	98.26%
165°	3.49	411.78	0.84%	99.10%
170°	2.34	414.12	0.56%	99.66%
175°	1.12	415.24	0.27%	99.93%
180°	0.28	415.52	0.07%	100.00%

Luminaire		Measur.		Lamp	
Code	05-4700-21-M1	Code	05-4699-21-M1	Code	TL5 HE sup80 21W/840
Name	Aplique CONCEPT 2x21W T5	Name	Aplique 2x14W T5 dif. acritico	Number	2
Line	- LEDS-C4	Date	25-06-2013	Position	Universal

Efficiency	41.55%	Coordinate system	CG	Total Flux	4200.00 lm
------------	--------	-------------------	----	------------	------------

Could not find 90270 right beam angle•gamma0180=0

Luminaire		Measuram.		Lamp	
Code	05-4700-21-M1	Code	05-4699-21-M1	Code	TL5 HE sup80 21W/840
Name	Aplique CONCEPT 2x21W T5	Name	Aplique 2x14W T5 dif. acritico	Number	2
Line	- LEDS-C4	Date	25-06-2013	Position	Universal
Efficiency	41.55%	Coordinate system	CG	Total Flux	4200.00 lm

Isolux (Floor)

Luminaire position X=0.00m Y=0.00m Z=1.80m

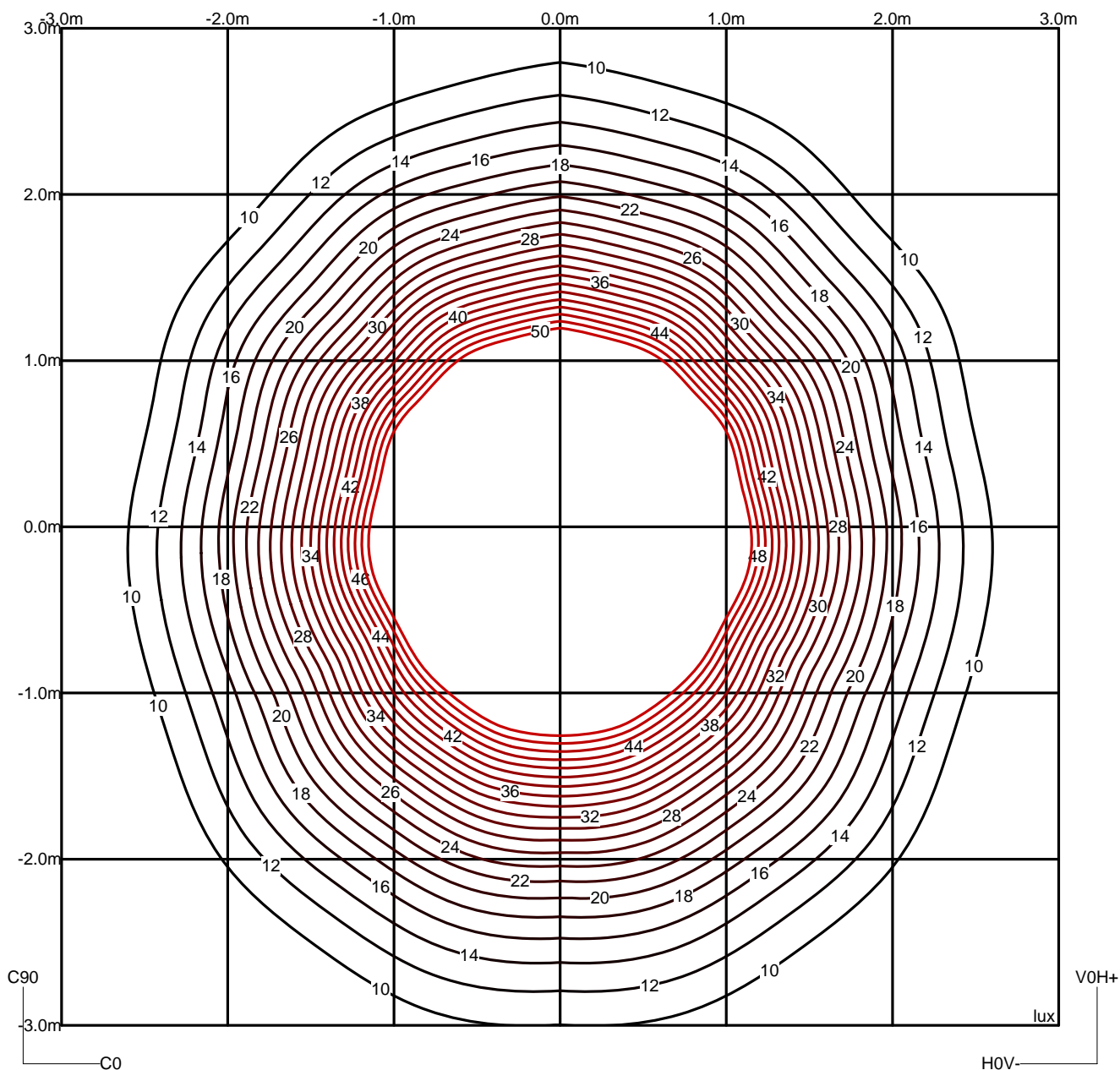

Luminaire	Measur.	Lamp
Code 05-4700-21-M1	Code 05-4699-21-M1	Code TL5 HE sup80 21W/840
Name Aplique CONCEPT 2x21W T5	Name Aplique 2x14W T5 dif. acritico	Number 2
Line - LEDS-C4	Date 25-06-2013	Position Universal

Efficiency	41.55%	Coordinate system	CG	Total Flux	4200.00 lm
------------	--------	-------------------	----	------------	------------

Utilizations CIE

Mounting	Direct	Normalization										Suspension Ratio					Standard CIE Settings							
		8873	8773	8871	8771	7773	7771	7753	7553	7751	7551	7731	7331	7711	7111	5551	5531	5331	5511	5111	3331	3311	1111	0000
	Ceiling	177	159	161	146	151	139	124	105	116	99	101	76	90	61	93	81	72	73	58	68	62	53	47
		198	181	174	161	173	153	142	124	129	114	112	89	99	73	106	94	84	84	69	80	72	63	56
		212	197	181	169	188	162	156	139	138	124	121	99	107	82	116	103	94	92	78	89	81	72	63
		225	212	185	175	201	168	170	154	146	133	128	109	114	91	125	111	103	100	87	98	89	80	70
		234	222	187	179	211	172	181	166	151	140	133	116	119	98	132	118	110	106	94	105	96	87	75
		245	235	188	181	224	175	196	184	156	147	141	126	127	109	140	127	121	116	105	115	106	98	84
		252	244	187	182	233	176	207	196	160	152	145	133	133	117	145	133	127	122	113	122	113	106	90
		257	250	186	182	239	177	215	205	162	155	149	138	137	123	148	137	132	127	119	128	119	112	94
		263	258	184	181	247	177	227	218	164	159	153	144	143	132	153	143	139	134	128	134	127	120	101
		267	263	182	180	251	176	234	227	165	161	156	149	147	137	155	147	144	139	133	139	132	126	105
		274	272	178	177	261	174	250	246	167	165	161	157	155	150	160	155	153	150	146	149	144	139	114
		278	276	174	173	266	171	259	257	167	166	164	162	160	158	162	159	158	156	154	154	151	147	120

Wall

K	8873	8773	8871	8771	7773	7771	7753	7553	7751	7551	7731	7331	7711	7111	5551	5531	5331	5511	5111	3331	3311	1111	0000
0.60	181	172	162	154	167	150	131	123	121	113	101	92	87	77	110	93	89	81	76	87	76	73	66
0.80	210	201	183	176	193	170	157	148	142	134	122	111	107	95	128	112	108	99	93	104	93	88	80
1.00	232	222	198	191	213	184	178	168	158	150	138	127	122	110	142	126	122	113	107	117	106	101	91
1.25	252	243	211	205	232	197	198	188	173	165	153	142	138	126	156	140	136	127	121	130	119	113	102
1.50	268	260	221	216	247	208	215	205	184	177	166	155	151	139	167	152	148	139	133	141	130	123	111
2.00	289	282	234	229	268	221	239	230	200	194	184	174	169	158	182	169	165	157	151	156	146	137	124
2.50	305	298	243	239	283	230	256	248	212	207	197	188	184	173	194	181	178	170	164	168	159	149	134
3.00	316	311	250	246	294	237	270	262	221	216	207	199	195	185	202	191	188	181	175	177	168	157	141
4.00	335	330	262	259	312	249	291	285	236	232	224	217	213	205	217	207	204	198	193	192	185	172	155
5.00	349	345	271	269	326	259	308	302	248	245	237	232	227	220	229	220	217	212	207	204	197	185	166
10.00	389	387	302	300	366	290	355	351	283	281	276	273	270	265	264	258	257	253	250	241	237	222	201
20.00	424	422	330	330	401	320	394	392	315	314	311	309	307	304	296	292	291	289	287	275	272	255	234

Working Pl.

K	8873	8773	8871	8771	7773	7771	7753	7553	7751	7551	7731	7331	7711	7111	5551	5531	5331	5511	5111	3331	3311	1111	0000
0.60	200	189	186	177	183	172	140	131	135	127	110	100	91	82	122	100	97	84	80	94	79	76	69
0.80	241	230	222	213	220	205	176	165	168	158	141	129	121	108	150	128	123	111	104	119	103	98	90
1.00	274	262	249	240	250	231	206	194	195	185	167	154	146	132	174	152	147	134	127	140	125	117	108
1.25	305	294	275	267	279	255	236	224	221	211	194	180	173	157	198	176	170	158	150	162	146	137	127
1.50	329	319	294	286	301	274	260	248	241	232	216	202	195	178	216	195	190	177	169	179	164	152	142
2.00	365	355	321	315	335	301	297	285	272	264	249	235	229	212	244	225	220	208	200	205	192	177	166
2.50	388	380	339	333	357	318	323	312	293	285	271	259	253	237	263	246	241	230	222	224	211	195	183
3.00	405	398	351	346	373	331	342	332	308	301	288	277	271	256	277	261	256	247	239	238	226	208	196
4.00	428	422	367	363	395	347	368	359	328	322	311	301	296	283	295	282	278	269	262	256	246	225	212
5.00	442	437	377	374	408	357	385	378	340	336	326	317	312	301	307	295	292	284	278	268	259	237	223
10.00	474	471	398	397	439	379	425	420	369	366	360	355	351	344	334	327	325	320	316	297	291	264	250
20.00	492	491	410	409	457	391	449	446	386	384	380	377	375	371	351	346	345	342	340	314	311	282	267

LM53 SHR C0-C180: 1.262 SHR C90-C270: 1.324 SHR Square: 1.402

Luminaire		Measur.				Lamp	
Code	05-4700-21-M1	Code	05-4699-21-M1		Code	TL5 HE sup80 21W/840	
Name	Aplique CONCEPT 2x21W T5	Name	Aplique 2x14W T5 dif. acritico		Number	2	
Line	- LEDS-C4	Date	25-06-2013		Position	Universal	
Efficiency	41.55%	Coordinate system	CG		Total Flux	4200.00 lm	

		Average Luminance [cd/m ²]										
		0.0°	45°	50°	55°	60°	65°	70°	75°	80°	85°	
90.0°		3482	4908	4750	4699	4614	4416	4328	3946	3732	3038	---
							2969	3271	3663	4105	4684	---

Flush mounted or longitudinal view													
		Illumination (lx)											
A	A	2000	1000	750	500			<300				1.15	
B	1		2000	1500	1000	750	500	<300				1.5	
C					2000			1000	500	<300		1.85	
D	2							2000	1000	500	<300	2.2	
E	3								2000	1000	500	<300	2.55

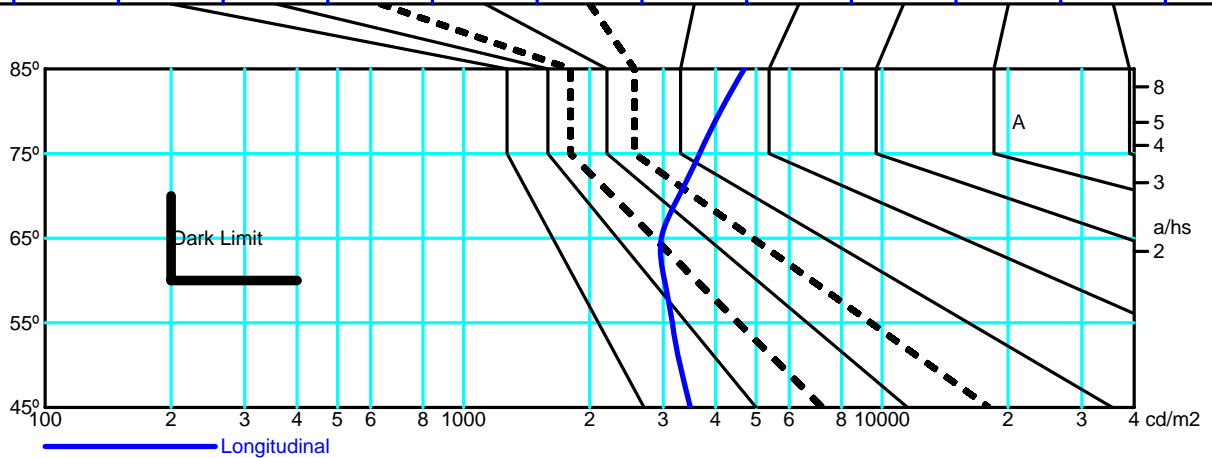

Flush mounted or transversal view													
		Illumination (lx)											
A	A	2000	1000	750	500			<300				1.15	
B	1		2000	1500	1000	750	500	<300				1.5	
C					2000			1000	500	<300		1.85	
D	2							2000	1000	500	<300	2.2	
E	3								2000	1000	500	<300	2.55

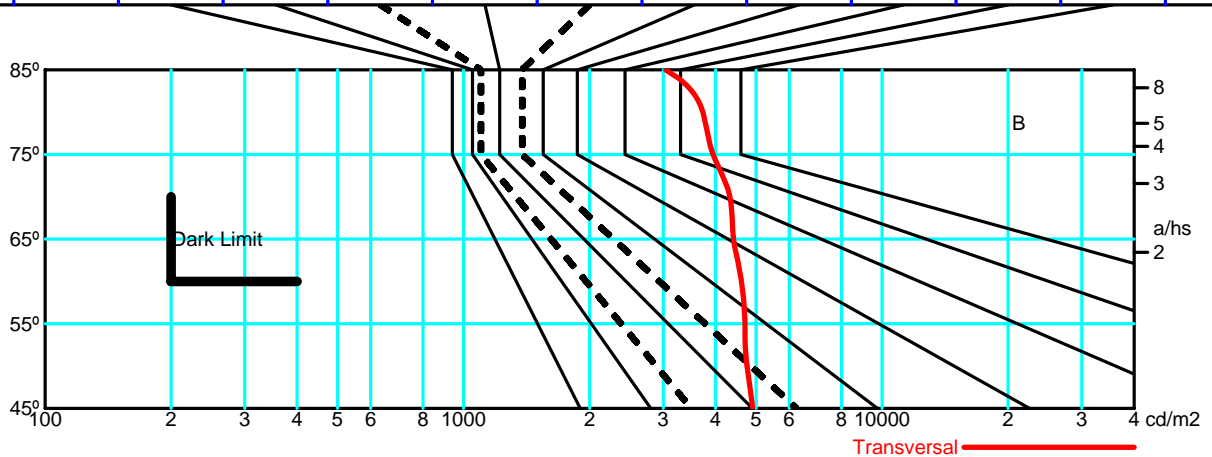

Luminaire		Measur.		Lamp	
Code	05-4700-21-M1	Code	05-4699-21-M1	Code	TL5 HE sup80 21W/840
Name	Aplique CONCEPT 2x21W T5	Name	Aplique 2x14W T5 dif. acritico	Number	2
Line	- LEDS-C4	Date	25-06-2013	Position	Universal
Efficiency	41.55%	Coordinate system	CG	Total Flux	4200.00 lm

Luminance

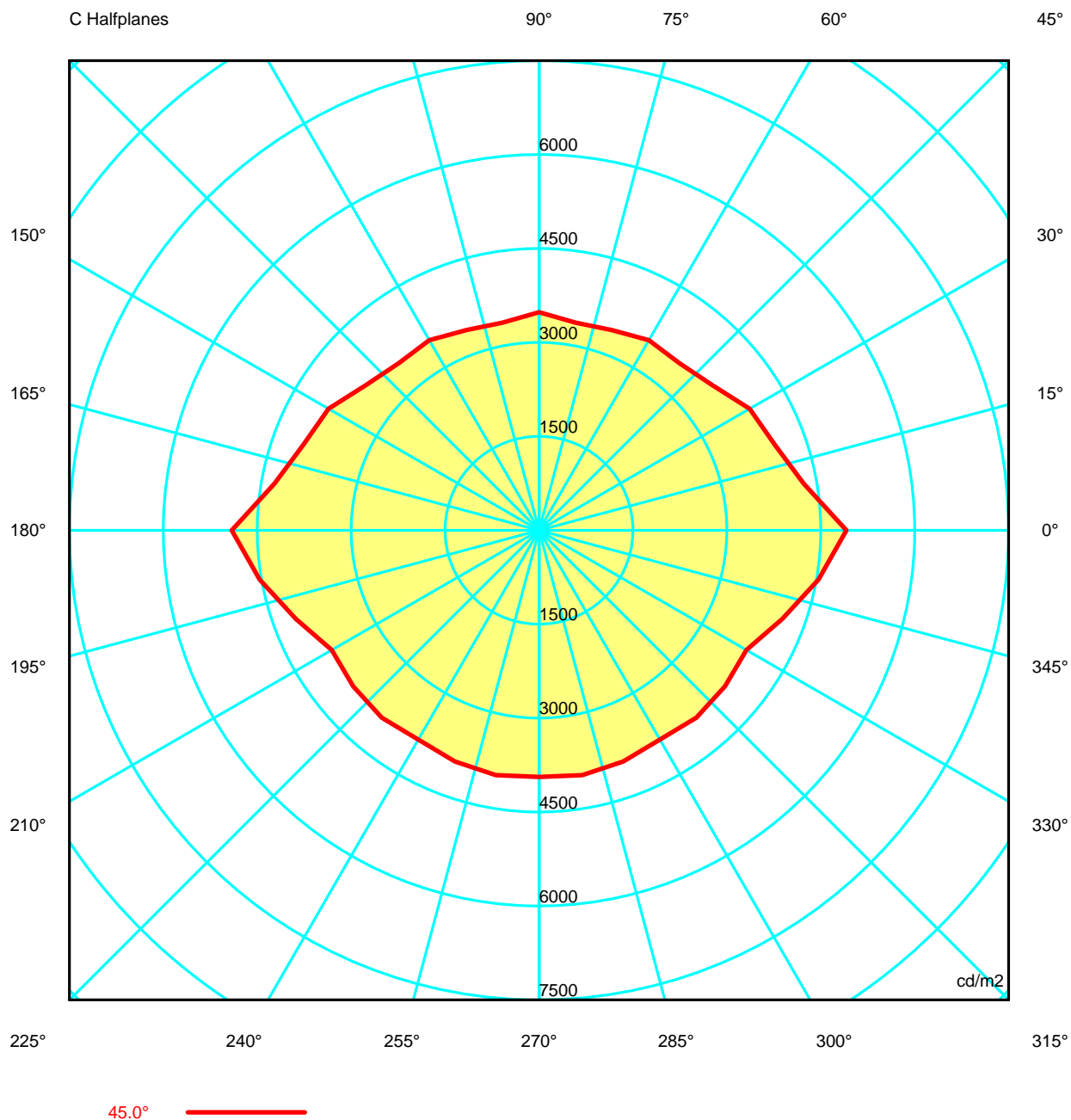

Luminaire		Measur.		Lamp									
Code	05-4700-21-M1	Code	05-4699-21-M1	Code	TL5 HE sup80 21W/840								
Name	Aplique CONCEPT 2x21W T5	Name	Aplique 2x14W T5 dif. acritico	Number	2								
Line	- LEDS-C4	Date	25-06-2013	Position	Universal								
Efficiency	41.55%	Coordinate system	CG	Total Flux	4200.00 lm								
Luminance cd/m2 Table 1/3													
	C 0.00	C 10.00	C 20.00	C 30.00	C 40.00	C 50.00	C 60.00	C 70.00	C 80.00	C 90.00	C 100.00	C 110.00	C 120.00
G 0.0	5341.51	5341.51	5341.51	5341.51	5341.51	5341.51	5341.51	5341.51	5341.51	5341.51	5341.51	5341.51	5341.51
G 5.0	5309.95	5250.15	5213.19	5180.47	5126.83	5097.41	5091.32	5065.04	5051.75	5067.53	5051.75	5065.04	5091.32
G 10.0	5296.43	5165.19	5084.14	5026.79	4924.72	4864.46	4849.89	4803.25	4783.02	4816.37	4783.02	4803.25	4849.89
G 15.0	5246.59	5051.30	4935.33	4862.33	4732.82	4657.75	4636.92	4565.65	4530.53	4570.99	4530.53	4565.65	4636.92
G 20.0	5218.24	4957.66	4805.00	4705.72	4528.63	4429.68	4412.89	4338.41	4305.02	4359.74	4305.02	4338.41	4412.89
G 25.0	5179.70	4827.67	4631.76	4541.70	4354.83	4246.28	4228.53	4147.94	4101.62	4140.26	4101.62	4147.94	4228.53
G 30.0	5103.79	4708.51	4494.50	4380.92	4167.13	4053.72	4045.85	3964.68	3924.60	3983.98	3924.60	3964.68	4045.85
G 35.0	5069.37	4573.36	4314.53	4199.30	3980.25	3871.12	3868.02	3771.86	3733.67	3823.34	3733.67	3771.86	3868.02
G 40.0	4952.67	4420.32	4153.49	4031.06	3799.83	3700.32	3710.36	3593.13	3537.18	3629.66	3537.18	3593.13	3710.36
G 45.0	4908.25	4291.93	4004.38	3882.61	3608.47	3484.63	3505.32	3403.21	3365.96	3481.95	3365.96	3403.21	3505.32
G 50.0	4750.33	4065.27	3780.29	3696.52	3429.39	3316.04	3349.33	3234.71	3180.49	3286.72	3180.49	3234.71	3349.33
G 55.0	4699.46	3925.48	3598.02	3493.58	3200.61	3084.62	3139.73	3054.51	3026.42	3153.71	3026.42	3054.51	3139.73
G 60.0	4614.35	3663.55	3307.17	3273.03	3011.88	2912.41	2992.61	2897.72	2880.80	3020.09	2880.80	2897.72	2992.61
G 65.0	4416.47	3427.60	3083.99	3029.33	2774.52	2705.55	2852.96	2920.63	2936.81	2968.81	2936.81	2920.63	2852.96
G 70.0	4328.09	3155.96	2799.59	2789.67	2639.25	2672.79	2934.96	3176.46	3239.90	3271.37	3239.90	3176.46	2934.96
G 75.0	3946.11	2684.42	2348.02	2491.27	2800.31	3067.35	3286.58	3528.59	3611.19	3663.50	3611.19	3528.59	3286.58
G 80.0	3731.92	2165.85	2142.93	2703.12	3211.87	3523.49	3732.50	3973.03	4050.11	4105.13	4050.11	3973.03	3732.50
G 85.0	3037.73	2128.14	2642.99	3286.87	3793.01	4087.74	4282.57	4520.36	4650.12	4683.87	4650.12	4520.36	4282.57
G 90.0	1259.52	2748.36	3827.01	4195.18	4613.03	4877.14	5025.28	5230.89	5345.63	5388.79	5345.63	5230.89	5025.28

Luminaire	Measur.	Lamp
Code 05-4700-21-M1	Code 05-4699-21-M1	Code TL5 HE sup80 21W/840
Name Aplique CONCEPT 2x21W T5	Name Aplique 2x14W T5 dif. acritico	Number 2
Line - LEDS-C4	Date 25-06-2013	Position Universal

Efficiency	41.55%	Coordinate system	CG	Total Flux	4200.00 lm
------------	--------	-------------------	----	------------	------------

	Luminance cd/m2 Table 2/3												
	C 130.00	C 140.00	C 150.00	C 160.00	C 170.00	C 180.00	C 190.00	C 200.00	C 210.00	C 220.00	C 230.00	C 240.00	C 250.00
G 0.0	5341.51	5341.51	5341.51	5341.51	5341.51	5341.51	5341.51	5341.51	5341.51	5341.51	5341.51	5341.51	5341.51
G 5.0	5097.41	5126.83	5180.47	5213.19	5250.15	5309.95	5276.56	5224.84	5166.99	5141.13	5115.87	5089.70	5076.51
G 10.0	4864.46	4924.72	5026.79	5084.14	5165.19	5296.43	5214.64	5103.60	5001.06	4960.45	4912.42	4853.41	4845.20
G 15.0	4657.75	4732.82	4862.33	4935.33	5051.30	5246.59	5125.57	4969.30	4833.35	4787.20	4722.71	4638.11	4629.14
G 20.0	4429.68	4528.63	4705.72	4805.00	4957.66	5218.24	5058.09	4848.03	4662.85	4599.84	4516.21	4412.23	4414.65
G 25.0	4246.28	4354.83	4541.70	4631.76	4827.67	5179.70	4954.96	4700.91	4486.51	4433.55	4346.88	4226.69	4225.94
G 30.0	4053.72	4167.13	4380.92	4494.50	4708.51	5103.79	4859.80	4566.18	4325.93	4253.28	4181.71	4094.08	4110.61
G 35.0	3871.12	3980.25	4199.30	4314.53	4573.36	5069.37	4793.12	4437.25	4140.89	4068.30	4051.03	4027.11	4059.37
G 40.0	3700.32	3799.83	4031.06	4153.49	4420.32	4952.67	4629.75	4264.91	3960.08	3974.88	3995.41	3951.19	3991.90
G 45.0	3484.63	3608.47	3882.61	4004.38	4291.93	4908.25	4529.82	4134.79	3823.71	3875.36	3907.06	3858.39	3927.90
G 50.0	3316.04	3429.39	3696.52	3780.29	4065.27	4750.33	4314.36	3913.40	3714.05	3809.99	3842.88	3784.22	3857.68
G 55.0	3084.62	3200.61	3493.58	3598.02	3925.48	4699.46	4175.36	3778.67	3634.04	3731.85	3735.24	3663.22	3761.63
G 60.0	2912.41	3011.88	3273.03	3307.17	3663.55	4614.35	3994.91	3590.32	3512.62	3630.04	3635.33	3574.33	3681.37
G 65.0	2705.55	2774.52	3029.33	3083.99	3427.60	4416.47	3797.53	3429.60	3368.50	3527.28	3529.51	3440.72	3565.67
G 70.0	2672.79	2639.25	2789.67	2799.59	3155.96	4328.09	3719.90	3327.92	3211.37	3388.16	3411.11	3327.12	3462.55
G 75.0	3067.35	2800.31	2491.27	2348.02	2684.42	3946.11	3418.31	3111.79	3033.91	3281.43	3310.63	3203.89	3376.94
G 80.0	3523.49	3211.87	2703.12	2142.93	2165.85	3731.92	3267.77	2950.59	2817.48	3071.82	3109.25	3016.10	3231.41
G 85.0	4087.74	3793.01	3286.87	2642.99	2128.14	3037.73	2710.61	2630.85	2556.84	2929.51	3004.44	2885.91	3098.27
G 90.0	4877.14	4613.03	4195.18	3827.01	2748.36	1259.52	2038.83	2418.86	2298.75	2729.54	2777.37	2610.94	2896.12

Luminaire	Measur.	Lamp
Code 05-4700-21-M1	Code 05-4699-21-M1	Code TL5 HE sup80 21W/840
Name Aplique CONCEPT 2x21W T5	Name Aplique 2x14W T5 dif. acritico	Number 2
Line - LEDS-C4	Date 25-06-2013	Position Universal

Efficiency	41.55%	Coordinate system	CG	Total Flux	4200.00 lm
------------	--------	-------------------	----	------------	------------

	Luminance cd/m2 Table 3/3												
	C 180.00	C 190.00	C 200.00	C 210.00	C 220.00	C 230.00	C 240.00	C 250.00	C 260.00	C 270.00	C 280.00	C 290.00	C 300.00
G 0.0	5341.51	5341.51	5341.51	5341.51	5341.51	5341.51	5341.51	5341.51	5341.51	5341.51	5341.51	5341.51	5341.51
G 5.0	5309.95	5276.56	5224.84	5166.99	5141.13	5115.87	5089.70	5076.51	5070.96	5071.23	5070.96	5076.51	5089.70
G 10.0	5296.43	5214.64	5103.60	5001.06	4960.45	4912.42	4853.41	4845.20	4843.74	4828.15	4843.74	4845.20	4853.41
G 15.0	5246.59	5125.57	4969.30	4833.35	4787.20	4722.71	4638.11	4629.14	4621.24	4581.96	4621.24	4629.14	4638.11
G 20.0	5218.24	5058.09	4848.03	4662.85	4599.84	4516.21	4412.23	4414.65	4418.01	4376.52	4418.01	4414.65	4412.23
G 25.0	5179.70	4954.96	4700.91	4486.51	4433.55	4346.88	4226.69	4225.94	4235.04	4203.18	4235.04	4225.94	4226.69
G 30.0	5103.79	4859.80	4566.18	4325.93	4253.28	4181.71	4094.08	4110.61	4124.97	4138.82	4124.97	4110.61	4094.08
G 35.0	5069.37	4793.12	4437.25	4140.89	4068.30	4051.03	4027.11	4059.37	4061.27	4062.41	4061.27	4059.37	4027.11
G 40.0	4952.67	4629.75	4264.91	3960.08	3974.88	3995.41	3951.19	3991.90	3998.99	3998.70	3998.99	3991.90	3951.19
G 45.0	4908.25	4529.82	4134.79	3823.71	3875.36	3907.06	3858.39	3927.90	3970.68	3937.53	3970.68	3927.90	3858.39
G 50.0	4750.33	4314.36	3913.40	3714.05	3809.99	3842.88	3784.22	3857.68	3891.10	3828.68	3891.10	3857.68	3784.22
G 55.0	4699.46	4175.36	3778.67	3634.04	3731.85	3735.24	3663.22	3761.63	3816.63	3757.62	3816.63	3761.63	3663.22
G 60.0	4614.35	3994.91	3590.32	3512.62	3630.04	3635.33	3574.33	3681.37	3723.73	3633.25	3723.73	3681.37	3574.33
G 65.0	4416.47	3797.53	3429.60	3368.50	3527.28	3529.51	3440.72	3565.67	3633.54	3556.20	3633.54	3565.67	3440.72
G 70.0	4328.09	3719.90	3327.92	3211.37	3388.16	3411.11	3327.12	3462.55	3528.61	3435.24	3528.61	3462.55	3327.12
G 75.0	3946.11	3418.31	3111.79	3033.91	3281.43	3310.63	3203.89	3376.94	3448.44	3300.05	3448.44	3376.94	3203.89
G 80.0	3731.92	3267.77	2950.59	2817.48	3071.82	3109.25	3016.10	3231.41	3336.15	3203.50	3336.15	3231.41	3016.10
G 85.0	3037.73	2710.61	2630.85	2556.84	2929.51	3004.44	2885.91	3098.27	3178.62	2989.14	3178.62	3098.27	2885.91
G 90.0	1259.52	2038.83	2418.86	2298.75	2729.54	2777.37	2610.94	2896.12	3036.66	2847.99	3036.66	2896.12	2610.94

